

## WL7 WETTED, FIREWALL AND ICE BATH DRAWINGS

Ice Bath

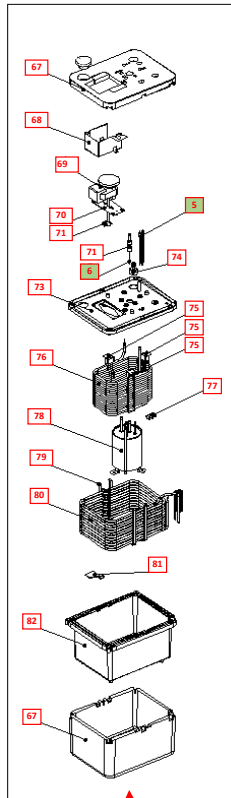





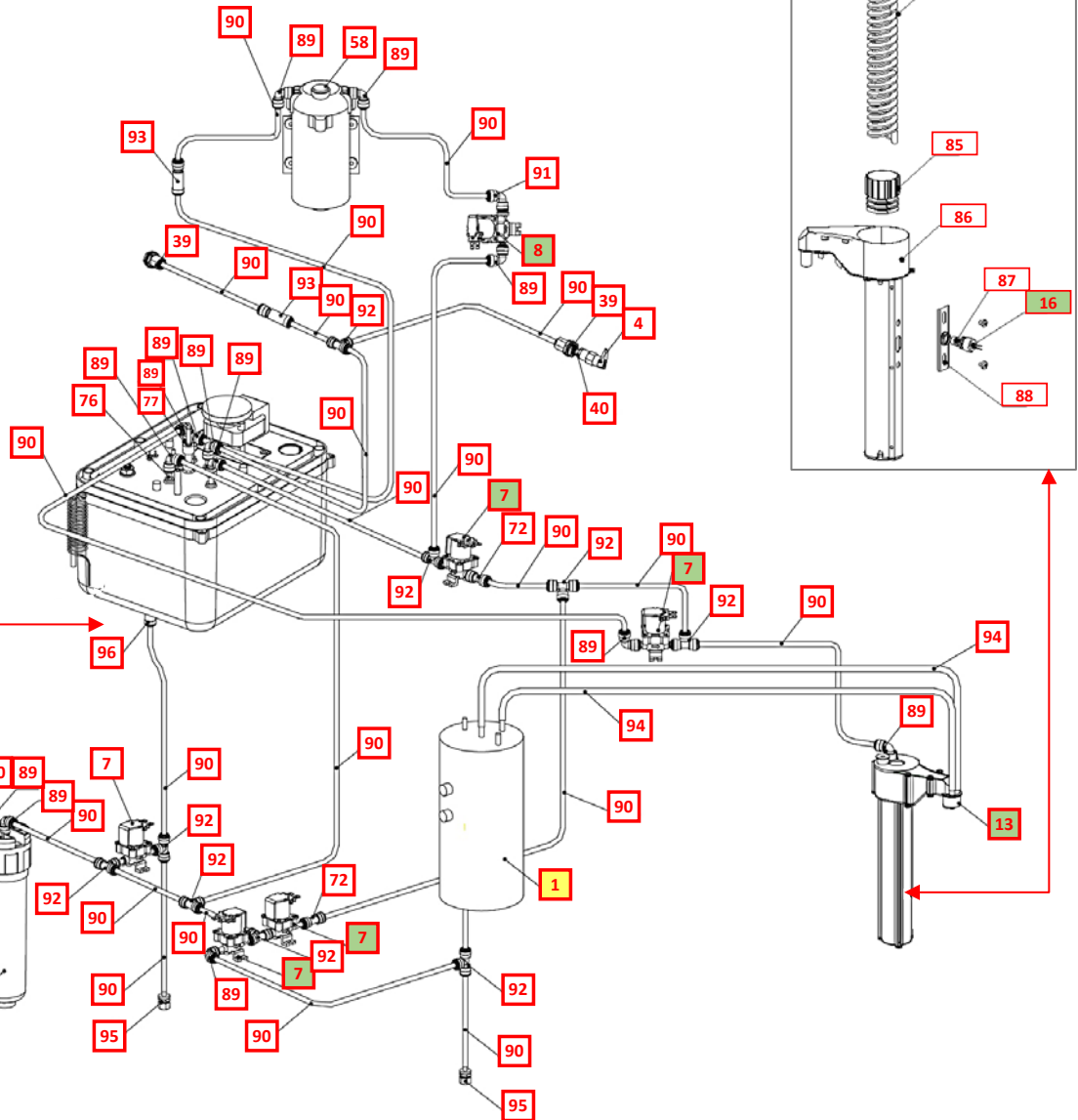

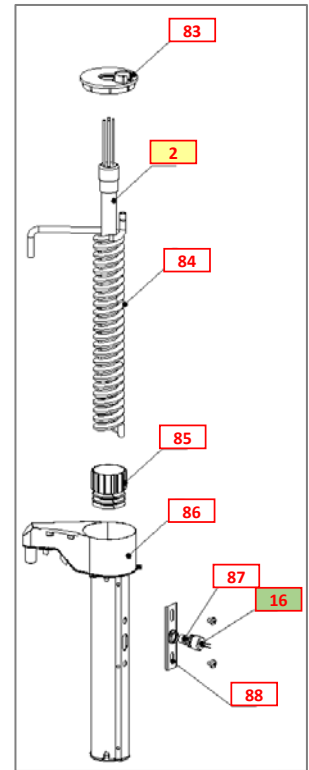

### WL7 FW SPARKLING









Wetted Drawing



















Firewall



No	WLCP PN	Description	Factory PN	Stocked?	
<b>Consumables</b>					
1	HT-0013-L00	1.5L 500W / 120V Hot Tank	HT-0013-L00-00	Yes	
1.1	10-3030	Hot Tank Temperature Sensor	HT-3001	Yes	
2	CT-2090-IBO-00	13W UV Lamp	CT-2090-I00-00-WL7	Yes	
3	FT-0053	Inline Sediment filter *Filter Element FT-0055-WLT for replacement cartridge	FT-0053-IL-WLT	Yes	
4	FT-0063	Inline 1micron CBC Cyst & Lead removal filter 1-micron 10" Inline for CTO, Lead, Cyst and Asbestos Reduction (Carbon Block) *Filter Element FT-0064 for replacement cartridge	FT-0063-IL-WLT	Yes	
Not Shown	01-2076	Scale Kleen	NA	Yes	
<b>Recommended Spare Parts</b>					
External to machine	PU-0013-L00-00d	Pressure Reducer <i>Recommend stocking 1 each for every 10 units purchased</i>	PU-0013-L00-00	Yes	
External to machine	AK-0003-L00	CO2 Pressure Regulator with tamper proof adjuster, preset to 35-45 psi, single output pressure gauge, inline shut-off valve, ¼ quick connect fitting, safety relief, and CO2 CGA-320 thread adapter. <i>Recommend stocking 1 each for every 10 units purchased</i>	AK-0003-P00-00	Yes	
5	CT-0028-L00	Ice Thickness Detection Probe <i>Recommend stocking 1 each for every 10 units purchased</i>	CT-0028-L00-00	Yes	
6	CT-0017-L00	Sparkling Level Probe <i>Recommend stocking 1 each for every 10 units purchased</i>	CT-0017-L00-00	Yes	
7	PU-0017-I00-00	MC DC Solenoid <i>Recommend stocking 2 each for every 10 units purchased</i>	PU-0017-I00-00	Yes	

8	PU-0021-I00-00	MS DC Solenoid – Terminals at Inlet <u>Recommend stocking 2 each for every 10 units purchased</u>	PU-0021-I00-00	Yes	
9	EN-0008-LA1-00	UV Electronic Ballast 15W - 120V/60Hz <u>Recommend stocking 1 each for every 10 units purchased</u>	EN-0008-LA1-00	Yes	
10	PL-0133-L00	Drip Tray Grill <u>Recommend stocking 2 each for every 10 units purchased</u>	PL-0133-L00-BL-WL7	Yes	
11	PL-0132-L00	Drip Tray <u>Recommend stocking 2 each for every 10 units purchased</u>	PL-0132-L00-BL-WL7	Yes	
12	EN-0067-L00-00	Ice Thickness Detection PCB <u>Recommend stocking 1 each for every 10 units purchased</u>	EN-0067-L00-00	Yes	
13	PL-0138-L00-00-WL7	Dispense Nozzle <u>Recommend stocking 2 each for every 10 units purchased</u>	PL-0138-L00-00-WL7	Yes	
14	User Interface Knob / PCB Assembly	Includes: a) Natural Faucet O-ring (P/N CT-2037), b) Spring for Button Switch (P/N ST-0157-L00-00-WL7), c) UI Knob (P/N PL-0134-L00-BL-WL7), d) UI Button Graphic Lens (P/N PL-0155-L00-00-WL7), e) User Interface PCB with Knob LED (P/N EN-0043-L00-00-WL7), f) User Interface Button (P/N PL-0135-L00-00-WL7), g) Knob Light Diffuser (P/N PL-0137-L00-00-WL7)  <u>Recommend stocking 1 each for every 10 units purchased</u>		Yes	
15	EN-0042-L00-00-WL7	Main PCB <u>Recommend stocking 1 each for every 10 units purchased</u>	EN-0042-L00-00-WL7	Yes	
16	AK-0064	UV Sensor <u>Recommend stocking 2 each for every 10 units purchased</u>	AK-0064	Yes	
<b>Remainder of Parts</b>					
17	ST-0125-L00	Metal Top Cover	ST-0125-L00-BL-WL7	Yes	
18	PL-0141-L00	Top Cover Insert	PL-0141-L00-BL-WL7	Yes	
19	NA	Ice Bath Assembly	AK-CT-2001-LB	No	

20	NA	Side Panel Corner Support	ST-0124-L00-00-WL7	No	
21	ST-0127-L00	Right Side Panel	ST-0127-L00-BL-WL7	Yes	
22	NA	Silicon gasket for display PCB	EN-0060-L00-00-WL7	No	
23	NA	User Interface Sealing Cover	PL-0139-L00-00-WL7	No	
24	NA	Spring Metal Cover for PCB Cover (Program Port)	ST-0160-L00-00-WL7	No	
25	NA	Adjustment Pin for Parent Door	ST-0201-L00-00	No	
26	NA	Door Latch	ST-0129-L00-00-WL7	No	
27	NA	Waterfall Light Backing	PL-0161-L00-00-WL7	No	
28	NA	Hinge	ST-0128-L00-00-WL7	No	
29	NA	LED PCB for Waterfall Back Light	EN-0044-L00-00-WL7	No	
30	NA	Waterfall Light Diffuser	PL-0136-L00-TR-WL7	No	
31	NA	Door Parent	PL-0129-L00-BL-WL7	No	
32	NA	User Interface Display Cover	PL-0140-L00-00-WL7	No	
33	NA	User Interface Insert Trim	PL-0131-L00-SI-WL7	No	
34	NA	Back Splash Trim	PL-0142-L00-SI-WL7	No	
35	NA	Door Dispense Area Insert	PL-0130-L00-SI-WL7	No	
36	NA	Spring for Door Latch	ST-0156-L00-00-WL7	No	

37	NA	Front Support Panel	ST-0135-L00-00-WL7	No	
38	NA	Metal Block Panel for Safety Valve	ST-0195-L00-00-WL7	No	
39	10-3067	JG Bulkhead Connector Union 1/4" * 1/4"(PI1208S)	PU-4028	Yes	
40	NA	Sparkling Safety Valve	ST-0105-L00-00	No	
41	10-7245	Upper Safety Valve 1/4"	CT-2037-I00-00	Yes	
42	NA	Hinge Pin	ST-0131-L00-00	No	
43	20-1010	2.8" Filter Clip	PU-4161	No	
44	NA	Compressor Cover	ST-0140-L00-00-WL7	No	
45	NA	Micro Switch Cover	ST-0155-L00-00-WL7	No	
46	14-5006	Micro Door Lock Switch <i>Alternate: P/N EL-0174-L00-00</i>	EL-5027	Yes	
47	NA	Transformer 120V	EN-0061-L00-00-WL7	No	
48	NA	Fan Motor Bracket	ST-0141-L00-00-WL7	No	
49	NA	Fan Motor 110V	CT-2011	No	
50	NA	Hot Tank Bracket	ST-0137-L00-00-WL7	No	
51	NA	Wing Nut M6 for Hot Tank	CS-0031-L00-00	No	
52	NA	Middle Support Panel	ST-0136-L00-00-WL7	No	
53	ST-0126-L00	Left Side Panel	ST-0126-L00-BL-WL7	Yes	

54	10-2200	Compressor (R134a 1/8HP) 110V/60Hz <i>Alternate: CO-0020-L00-00</i>	CO-9001A	Yes	
55	NA	Bottom Shelf	ST-0132-L00-BL-WL7	No	
56	10-4004	Plastic Handle	PL-1120	Yes	
57	12-3150	Rubber Feet	PL-1251CN	Yes	
58	NA	75 GDP RO DC Pump	CT-0007-L00-00	No	
59	NA	High Efficiency Wire Condenser	CT-0026-L00-00-WL7	No	
60	NA	Corner Support	ST-0133-L00-BL-WL7	No	
61	NA	Back panel	ST-0134-L00-BL-WL7	No	
62	19-1090	Power Socket	EL-5029	Yes	
63	10-3014	Fuse Holder & Fuse 110V/15A	EL-5053	Yes	
64	10-3009	Green Heater / Compressor Switch	EL-5005	Yes	
65	10-3008	Red Power Switch	EL-5004	Yes	
66	NA	Electric Power Box	ST-0123-L00-00-WL7	No	
67	NA	EPS-Body, Top and Window Cover	PC-0127-L00-00	No	
68	NA	Motor Metal Bracket	ST-0162-L00-00	No	
69	NA	Ice Bath Motor 120V	EN-0047-L00-00	No	

70	NA	Ice Bath Top Cover for Motor Service	PL-0152-L00-00	No	
71	NA	Ice Bath Impeller	PL-0153-L00-00	No	
72	NA	JG Equal Straight Connector 1/4"(PI0408S)	PU-4010	No	
73	NA	Ice Bath Top Cover	PL-0151-L00-00	No	
74	NA	Ice Bath Water Level Float	EL-0142-L00-00	No	
75	NA	Ice Bath Bracket for the Cooling Pipe	ST-0148-L00-00	No	
76	NA	Ice Bath Stainless Cold Water Pipe	ST-0150-L00-00	No	
77	NA	Ice Bath Spacer	PL-0201-L00-00	No	
78	NA	Ice Bath Sparkling Tank	CT-0015-L00-00	No	
79	NA	Ice Bath Bracket for Evaporator	ST-0147-L00-00	No	
80	NA	Ice Bath - Stainless Evaporator	CO-0015-L00-00	No	
81	NA	Metal Bracket to Block Ice Bath Inlet Hole	ST-0213-L00-00	No	
82	NA	Ice Bath Body	PL-0150-L00-00	No	
83	10-8095	UV Firewall Fixing Seal	CT-2078-B	Yes	

84	FW-0008-L00	Spiral Quartz Sleeve	FW-0008-L00-00	Yes	
85	NA	Spiral Buffer Rubber	FW-0021-L00-00	No	
86	NA	Firewall Mirror Assembly	FW-0026-L00-00-WL7	No	
87	NA	UVC Sensor Silicone	PL-1358-A	No	
88	NA	UVC Sensor Fixing Metal Bracket	FU-0012	No	
89	NA	JG Equal Elbow Connector 1/4" (PI0308S)	PU-4008	No	
90	NA	1/4" PE Tubing	PU-4031	No	
91	NA	JG Stem Elbow Connector 1/4" * 1/4" - (PI220808S)	PU-4066	No	
92	NA	JG Equal Tee Connector 1/4" (PI0208S)	PU-4011	No	
93	NA	JG Non-Return Valve 1/4"	PU-4057	No	
94	NA	Silicone Pipe 5/16"	PL-4064-L00-00	No	
95	NA	Drain Valve Assembly	CT-2028, CT-2039-A, CT-2044, CT-2082	Yes	
96	NA	JG 3/8" x 1/4" Reducing Fitting(PI211208S)	PU-4137	No	
Not shown	10-3007	Power Cord 120V – 1840 mm	EL-5001-B	Yes	