

SERVICE REQUIREMENTS

⚠ WARNING! *Read and understand the contents of this manual before attempting to service the P2 Classe. Failure to follow the instructions in this manual could result in death, serious personal injury, or severe property damage. Only trained and qualified technicians should attempt to install, maintain, or service Waterlogic Equipment.*

1. Visually inspect all electrical and water connections for signs of wear or damage.

⚠ DANGER! ***HIGH VOLTAGE ELECTRICAL HAZARD.** Unplug before inspection and service.*

2. **Waterlogic** recommends changing the UV Lamp every 12 months.

NOTE: When replacing the UV Lamp Assembly, the UV Lamp wiring harness must also be replaced.



UV Lamp Assembly Part #:
15-Watt Bulb 12-8310 (CT-2085)

⚠ WARNING! ***ULTRAVIOLET RADIATION.** Protect your skin and eyes against ultraviolet rays. Never look directly at an operating UV light. Disconnect before removing UV Lamp.*

⚠ CAUTION! ***UV LAMPS ARE HAZARDOUS.** Lamps are considered Hazardous Waste and must be disposed of accordingly. Refer to Product MSDS sheet for details.*

⚠ CAUTION! ***UV SYSTEM IS FRAGILE.** Never handle the UV lamp or Quartz Sleeve with bare hands. UV Lamp and quartz sleeve must be free of oils and contaminants to ensure proper operation. Use a soft non-abrasive cloth to clean.*

3. Ensure there is adequate (minimum of 2") clearance around the **P2 Classe** and clean the condenser fins and compressor fan to provide efficient cooling system operation.

4. Sanitize the cold tank per instructions in the pre-installation procedures.

⚠ WARNING! ***SANITIZER MAY CONTAIN HAZARDOUS CHEMICALS.** Use of proper personal protective equipment such as rubber gloves and eye protection is required.*

5. Clean and sanitize external surfaces of the **P2 Classe**. Use soap and water or chemicals that are compatible with ABS plastic and will not damage or degrade the product surfaces.

REPLACEMENT COMPONENTS (CONSUMABLES)

Component	WLCP Part No.	Frequency of Replacement
UV Bulb, 15 Watts Assembly	12-2350	Every 12 months, or as required CT-2030-I00-00

⚠ CAUTION! Use only Waterlogic Replacement parts that can be obtained from *Waterlogic* or an *Authorized Waterlogic Dealer*, failure to do so will void the Warranty.

See Installation and Service Manual for additional information.

Surface Cleaning

Clean on a regular basis with damp lint free cloth. Never use harsh chemicals (alcohol or acid based) or abrasive agents on any part of the product to avoid damage. A mild cleaner such as Simple Green or equivalent is recommended.

DISPOSAL

End of Life

At the **end of this product's life**, ensure that it is disposed of in an environmentally friendly manner which is fully compliant **with all Federal/State/Local Requirements and Guidelines**. Do not dispose of this appliance with normal household or business waste.

P2 CLASSE DRAWING AND PARTS LIST

Wetted Drawing

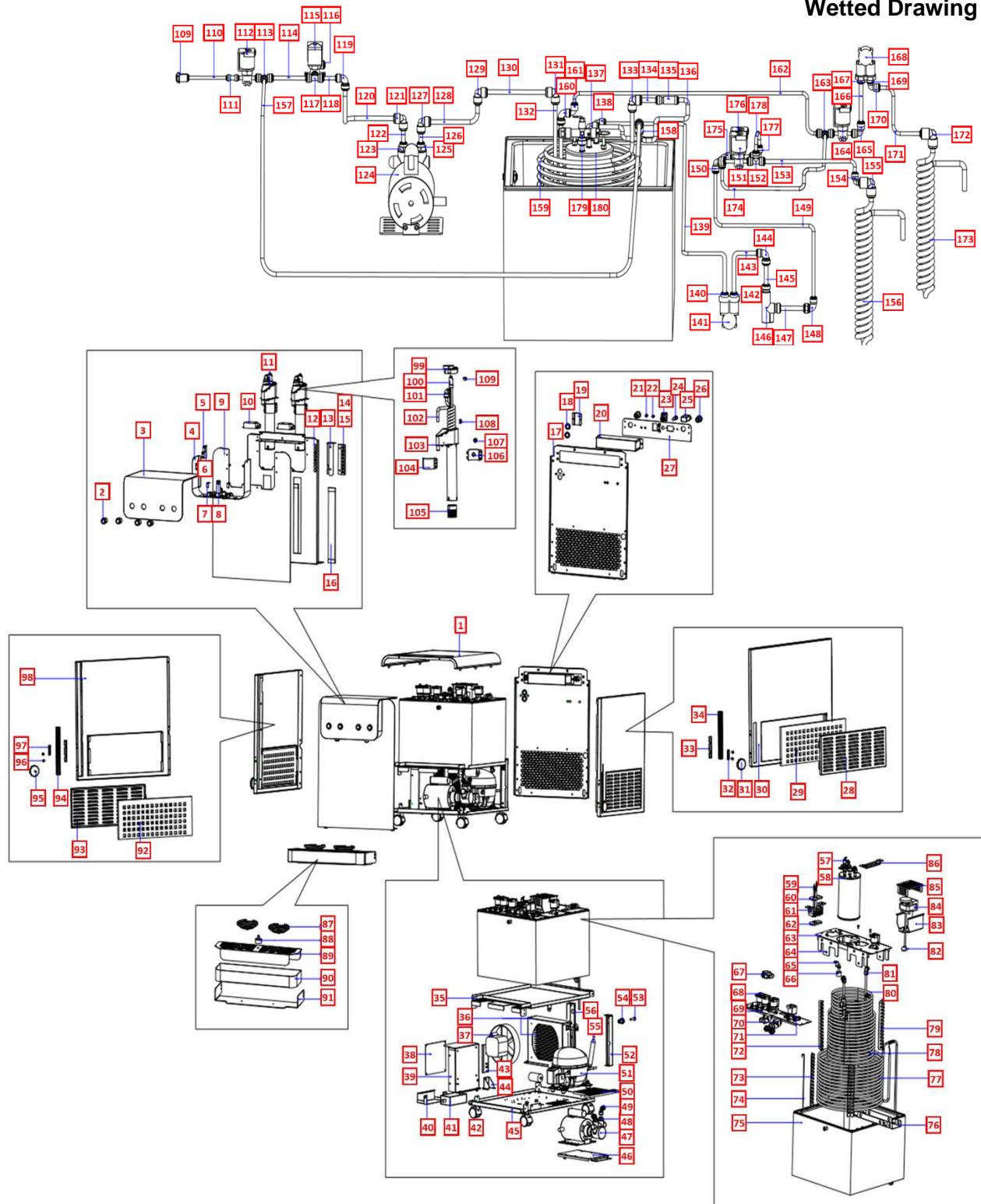





No	WLCP Part No.	Description	Picture
1	ST-0240-L00-00	Classe Top Cover	
2	EN-0098-L00-00	Metal Push Button	
3	ST-0239-L00-00	Classe Aluminum UI Panel with Purezza Logo	
4	ST-0241-L00-00	Classe UI Case	
5	EL-0174-L00-00	Micro Switch w/ Lever	
6	ST-0272-L00-00	Classe Micro Switch Cover	
7	ST-0267-L00-00	Classe UI Hinge Stopper	
8	PU-0027-L00-00	ODL Compensator	
9	PL-0243-L00-00	Classe Front Panel	
10	EN-0008-LA1-00	13W/15W 120V/60Hz Electronic FX Ballast	
11	N/A	HoReCa Firewall	
12	ST-0238-L00-00	Classe Front Panel	
13	ST-0260-L00-00	Classe LED PCB Bracket	

14	EN-0093-L00-00	Classe LED PCB Indicator	
15	PL-0267-L00-00	Classe LED PCB Shading Plate	
16	EN-0097-L00-00	Classe Back Light	
17	ST-0237-L00-00	Classe Back Panel	
18	PL-1293	Rubber O-ring for GF Side Panel Drain Hole	
19	ST-0326-L00-00	Classe Back Hole Cover	
20	ST-0246-L00-00	Classe Electric Cover	
21	EL-0206-L00-00	Classe Reset Filter Timer/Sleep Wire	
22			
23	EL-5004	Switch - Power (Red)	
24	EL-0021-L00-00	WL Cube Fuse 120V 15A with wire	
25	EL-5029	Socket for Plug Connection	
26	PU-4028	JG Bulkhead Connector Union 1/4" x 1/4"	
27	ST-0333-L00-00	Classe Back Electric Fixing Panel (USA)	

28	ST-0304-L00-00	Classe Louvered Side Window with SUS304-Right	
29	CS-0073-I00-00	Classe Air Filter	
30	ST-0235-L00-00	Classe Side Panel - Right - Purezza logo	
31	ST-0285-L00-00	Classe Side Panel Lock Knob – Right	
32	ST-0283-L00-00	Classe Rail Bracket Sample Short – Right	
33	ST-0281-L00-00	Classe Rail Bracket Sample Long	
34	ST-0280-L00-00	Classe Drip Tray Body Rail	
35	ST-0244-L00-00	Classe Ice Bath Bracket	
36	CO-0035-L00-00	Classe Micro Channel Condenser	
	ST-0302-L00-00	Classe Micro Channel Condenser Metal Case	
37	EN-0091-L00-00	Fan Motor and Blade 120V- M4Q045 -172/34	
38	EN-0092-L00-00	Classe Main Control PCB	
39	ST-0251-L00-00	Classe PCB Case	

40	ST-0259-L00-00	Classe Adaptor Bracket	
41	EL-0126-L00-00	GF MAX Adaptor	
42	CS-0089-L00-00	Lockable Wheel	
43	ST-0250-L00-00	Classe Fan Bracket 2	
44	ST-0249-L00-00	Classe Fan Bracket 1	
45	ST-0236-L00-00	Classe Base Plate	
46	ST-0262-L00-00	Classe Pump Bracket	
47	EN-0095-L00-00	Brass Vane Pump P201 and Pump Motor 120VAC	
48	PU-0024-I00-00	JG Straight Adaptor 8mm x 3/8" BSP	
49	PU-4089KR	Equal Elbow 5/16" x 5/16"	
50	CS-0093-L00-00	Classe Bottom Air Filter	
51	CO-0042-L00-00	LG Compressor 120V -CMA062LHCM	
52	ST-0248-L00-00	Classe Back Bracket – Right	





53	PU-4086	JG 1/4" Plug	
54	PU-4028	JG Bulkhead Connector Union 1/4" x 1/4"	
55	CO-9025	Domestic Filter Dryer (WL3000, WL950) 15.88*6.35*2.1(10g)	
56	ST-0247-L00-00	Classe Back Bracket – Left	
57	PU-0028-I00-00	Sparkling Safety Valve Kit	
58	CT-0040-I00-00	Classe Sparkling Tank	
59	CT-0028-L00-00	WL7 Ice Thickness Detection Probe	
60	PL-0245-L00-00	Classe Bracket for Ice Probe	
61	ST-0252-L00-00	Classe Ice Probe Bracket	
62	PL-0257-L00-00	Classe Bracket for Ice Probe Down	
63	ST-0255-L00-00	Classe Ice Bath Top Bracket	
64	PL-0244-L00-00	Classe Separating Plate for Cooling/Water Pipe	
65	ST-0268-L00-00	Classe water Float Bracket	



66	EN-0106-L00-00	Classe Water Level Float	
67	RO-0024	High Water Pressure Switch	
68	PU-0021-I00-00	MS DC Solenoid Valve SWV24-02 Terminal at Inlet	
69	ST-0261-L00-00	Classe Solenoid Valve Bracket	
70	EN-0096-L00-00	Gicar Flow Counter FMPL-F-L-G1/4 d.3.7	
71	PU-4011	JG Equal Tee Connector 1/4"	
72	ST-0257-L00-00	Classe Sparkling Pipe Fix Bracket	
73	ST-0258-L00-00	Classe Cooling Pipe Fix Bracket	
74	ST-0287-L00-00	Classe Cooling Pipe Fixing Pin	
75	PL-0246-L00-00	Classe Ice Bath Box	
76	ST-0270-L00-00	Classe Pipe Bottom Metal Separator	
77	CT-0038-I00-00	Classe SUS304 Gas Cooling Pipe	SEE DIAGRAM
78	CT-0037-I00-00	Classe SUS304 Water Cooling Pipe	SEE DIAGRAM

79	ST-0256-L00-00	Classe Cold Pipe Fix Bracket	
80	CT-0039-I00-00	Classe Sparkling Water Pipe	SEE DIAGRAM
81	PU-4089KR	Equal Elbow 5/16" x 5/16"	
82	PL-0256-L00-00	Classe Ice Bath Agitator Blade	
83	ST-0253-L00-00	Classe Agitator Bracket	
84	EN-0102-L00-00	ICE Bath Agitator 120V 187MM	
85	ST-0266-L00-00	Classe Agitator Safety Cover	
86	ST-0254-L00-00	Classe Sparkling Tank Bracket	SEE DIAGRAM
87	PL-0254-L00-00	Classe Bottle Guide	
88	PL-0281-L00-00	Drip Tray Floater Universal	
89	ST-0242-L00-00	Classe Drip Tray Grill	
90	ST-0243-L00-00	Classe Drip Tray Body	
91	ST-0263-L00-00	Classe Drip Tray Body support	

92	CS-0073-L00-00	Classe Air Filter	
93	ST-0303-L00-00	Classe Louvered Side Window with SUS304-Left	
94	ST-0280-L00-00	Classe Drip Tray Body Rail	
95	ST-0284-L00-00	Classe Side Panel Lock Knob - Left	
96	ST-0286-L00-00	Classe Drip Tray Support Bolt	
97	ST-0282-L00-00	Classe Rail Bracket Sample Short - Left	
98	ST-0234-L00-00	Classe Side Panel - Left – Purezza Logo	
99	CT-2088	WL200 Firewall UV Lamp Fixing Rubber	
100	CT-2085-LA0-00	15W LTFW XTM UV Lamp – 80	
101	PU-4137	JG 3/8" x 1/4" Reducing Fitting	
102	FW-0034-L00-00	HoReCa FW Spiral Quartz Sleeve	
103	FW-0044-L00-00	HoReCa FW Housing	
104	FU-0011	UVC Sensor Fixing Metal Bracket Brack	

105	FU-0010	UVC Sensor Fixing Metal Bracket w/ Tube	
106	CT-2089 EL-5146 PL-1358	UVC Sensor + Wire + Fixing Rubber	
107	FW-0040-L00-00	HoReCa FW Spiral Vibration Stop O-ring	
108	CT-2010	CDS Fixing Rubber	
109	PU-4028	JG Bulkhead Connector Union 1/4" x 1/4"	
110	PU-4031	JG LLD PE Tube - Blue O.D. 1/4"	
111	PU-4010	JG Equal Straight Connector 1/4"	
112	PU-0021-I00-00	MS DC Solenoid Valve SWV24-02 Terminal at Inlet	
113	PU-4011	JG Equal Tee Connector 1/4"	
114	PU-4031	JG LLD PE Tube - Blue O.D. 1/4"	
115	PU-0021-I00-00	MS DC Solenoid Valve SWV24-02 Terminal at Inlet	
116	PU-4008	JG Equal Elbow Connector 1/4"	
117	PU-4011	JG Equal Tee Connector 1/4"	

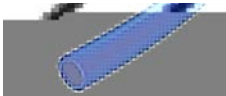
118	PU-4031	JG LLD PE Tube - Blue O.D. 1/4"	
119	PU-4007	JG Reducing Elbow Connector 5/16" x 1/4"	
120	PU-4014	JG LLDPE Tube - Blue 8mm Import	
121	PU-4089KR	JG Equal Elbow 5/16" x 5/16"	
122	PU-4014	JG LLDPE Tube - Blue 8mm Import	
123	PU-0024-I00-00	JG Straight Adaptor 8mm x 3/8" BSP	
124	EN-0095-L00-00	Brass vane Pump P201 and Pump Motor 120V AC	
125	PU-0024-I00-00	JG Straight Adaptor 8mm x 3/8" BSP	
126	PU-4014	JG LLDPE Tube - Blue 8mm Import	
127	PU-4089KR	JG Equal Elbow 5/16" x 5/16"	
128	PU-4014	JG LLDPE Tube - Blue 8mm Import	
129	PU-4089KR	JG Equal Elbow 5/16" x 5/16"	
130	PU-4014	JG LLDPE Tube - Blue 8mm Import	

131	PU-4089KR	JG Equal Elbow 5/16" x 5/16"	
132	CT-0039-I00-00	Classe Sparkling Water Pipe	SEE DIAGRAM
133	PU-4089KR	JG Equal Elbow 5/16" x 5/16"	
134	PU-4014	JG LLDPE Tube - Blue 8mm Import	
135	PU-0023-I00-00	JG Non-Return Valve 5/16"	
136	PU-4014	JG LLDPE Tube - Blue 8mm Import	
137	PU-4089KR	JG Equal Elbow 5/16" x 5/16"	
138	PU-4007	JG Reducing Elbow Connector 5/16" x 1/4"	
139	PU-4031	JG LLD PE Tube - Blue O.D. 1/4"	
140	PU-0025-I00-00	JG Straight Adaptor 1/4" x 1/4"	
141	EN-0096-L00-00	Gicar Flow Counter FMPL-F-L-G1/4 d.3.7	
142	PU-0025-I00-00	JG Straight Adaptor 1/4" x 1/4"	
143	PU-4031	JG LLD PE Tube - Blue O.D. 1/4"	

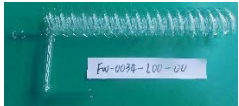
144	PU-4007	JG Reducing Elbow Connector 5/16" x 1/4"	
145	PU-4014	JG LLDPE Tube - Blue 8mm Import	
146	PU-0027-L00-00	ODL Compensator	
147	PU-4014	JG LLDPE Tube - Blue 8mm Import	
148	PU-4089KR	JG Equal Elbow 5/16" x 5/16"	
149	PU-4014	JG LLDPE Tube - Blue 8mm Import	
150	PU-4007	JG Reducing Elbow Connector 5/16" x 1/4"	
151	PU-0021-I00-00	MS DC Solenoid Valve SWV24-02 Terminal at Inlet	
152	PU-4011	JG Equal Tee Connector 1/4"	
153	PU-4031	JG LLD PE Tube - Blue O.D. 1/4"	
154	PU-4066	JG Stem Elbow Connector 1/4" x 1/4"	
155	PU-4137	JG 3/8" x 1/4" Reducing Fitting	
156	FW-0034-L00-00	HORECA FW Sprial Quartz Sleeve	

157	PU-4031	JG LLD PE Tube - Blue O.D. 1/4"	
158	PU-4007	JG Reducing Elbow Connector 5/16" x 1/4"	
159	CT-0037-I00-00	Classe SUS304 Water Cooling Pipe	SEE DIAGRAM
160	PU-4007	JG Reducing Elbow Connector 5/16" x 1/4"	
161	PU-4066	JG Stem Elbow Connector 1/4" x 1/4"	
162	PU-4014	JG LLDPE Tube - Blue 8mm Import	
163	PU-4011	JG Equal Tee Connector 1/4"	
164	PU-0021-I00-00	MS DC Solenoid Valve SWV24-02 Terminal at Inlet	
165	PU-4008	JG Equal Elbow Connector 1/4"	
166	PU-4031	JG LLD PE Tube - Blue O.D. 1/4"	
167	PU-0025-I00-00	JG Straight Adaptor 1/4" x 1/4"	
168	EN-0096-L00-00	Gicar Flow Counter FMPL-F-L-G1/4 d.3.7	
169	PU-0025-I00-00	JG Straight Adaptor 1/4" x 1/4"	

170	PU-4066	JG Stem Elbow Connector 1/4" x 1/4"	
171	PU-4031	JG LLD PE Tube - Blue O.D. 1/4"	
172	PU-4137	JG 3/8" x 1/4" Reducing Fitting	
173	FW-0034-L00-00	HORECA FW Sprial Quartz Sleeve	
174	PU-4031	JG LLD PE Tube - Blue O.D. 1/4"	
175	PU-4008	JG Equal Elbow Connector 1/4"	
176	PU-0021-I00-00	MS DC Solenoid Valve SWV24-02 Terminal at Inlet	
177	PU-4008	JG Equal Elbow Connector 1/4"	
178	PU-4031	JG LLD PE Tube - Blue O.D. 1/4"	
179	PU-0028-I00-00	Sparkling Safety Valve Kit	
180	CT-0040-I00-00	Classe Sparkling Tank	

P2 CLASSE WATER FLOW DIAGRAM

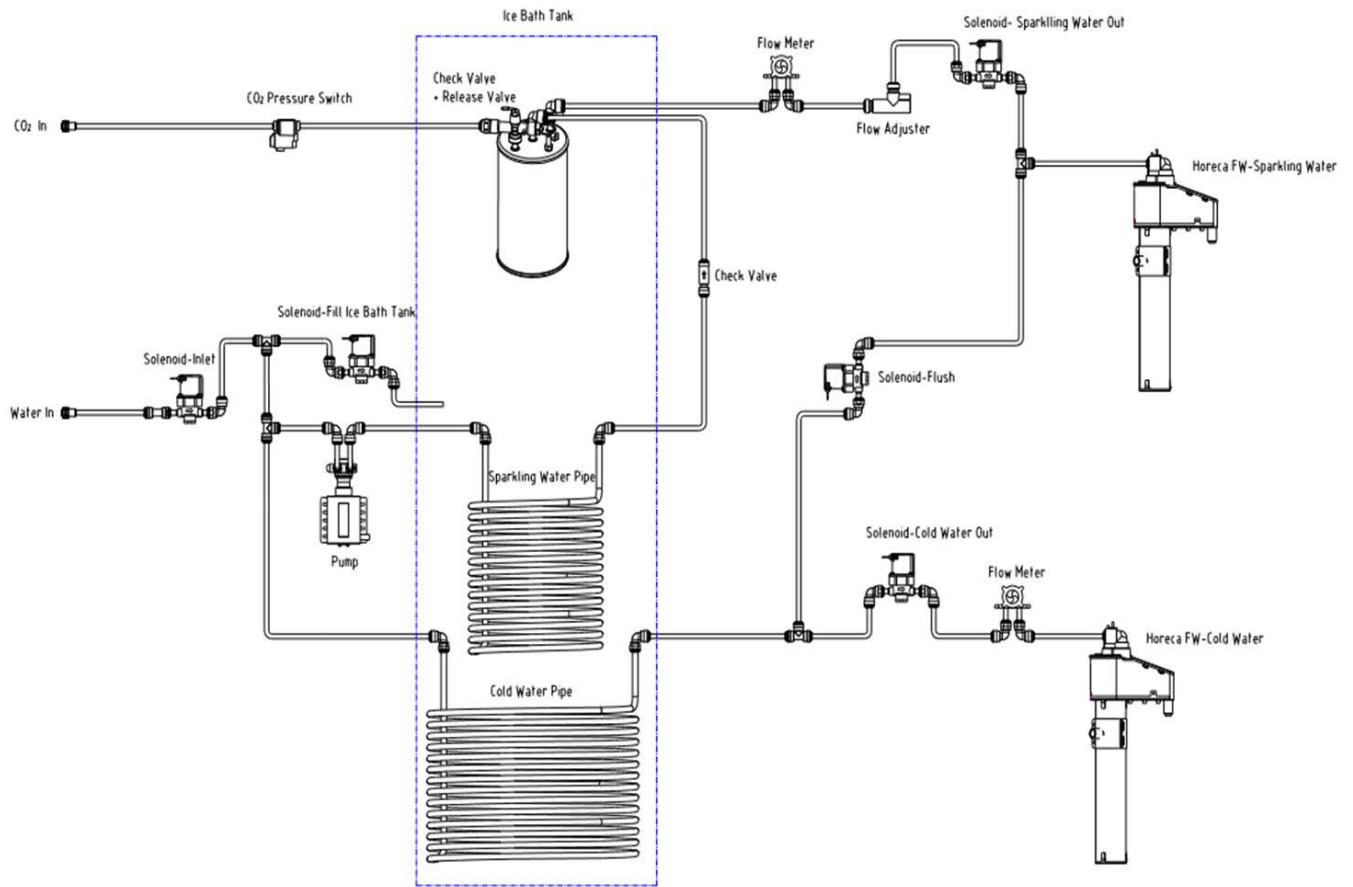

P2 CLASSE ELECTRICAL DIAGRAM

⚠ DANGER! HIGH VOLTAGE ELECTRICAL HAZARD. PCB (Printed Circuit Board) contains High Voltage. Only trained and qualified technicians should attempt live testing.

