



WL2FL MANUAL



Waterlogic Commercial Products, LLC
3175 Bass Pro Drive
Grapevine, TX 76051
(800) 288-1891 www.waterlogicdealers.com
Tech Portal Website: wld-portal.waterlogic.com

WL2FL MANUAL

Congratulations on your choice of the **Waterlogic WL2FL Water Treatment System**. The **WL2FL Water Treatment System** model dispenses cold, and hot. Every **WL2FL Water Treatment System** includes:



High Performance Multi-Stage Filtration



Bio-Cote Anti-Microbial Protection



Firewall™ Advanced Purification

The **Waterlogic WL2FL Water Treatment System** provides exceptional quality and great tasting water with every use.

INTRODUCTION

Carefully read and follow all instructions to ensure proper and efficient operation of your **WL2FL Water Treatment Systems**. Contact **Waterlogic** or an **Authorized Waterlogic Dealer** if you have any questions.

Waterlogic and **Authorized Waterlogic Dealers** employ trained service personnel who are experienced in the installation, function and repair of **Waterlogic** equipment. This publication is written for use by these qualified individuals. **Waterlogic** encourages users to learn about products, however, we believe that product knowledge and service is best obtained by consulting **Waterlogic** or an **Authorized Waterlogic Dealer**.

Waterlogic Water Treatment Systems should be combined with selected water treatment components to create a system specifically tailored for each application by trained and qualified personnel.

Products manufactured and marketed by **Waterlogic** and its affiliates are protected by patents issued or pending in the United States and other countries.

Waterlogic reserves the right to change the specifications referred to in this literature at any time, without prior notice. Changes or modifications not expressly approved by **Waterlogic** could void the warranty and user's authority to operate the equipment.

TABLE OF CONTENTS

USER GUIDE

- Safety Alert Symbols 4
- Safety Precautions 4
- Features and Benefits 6
- Certifications 7
- Model Designations and General Specifications 9
- Electrical and Shipping Specifications..... 10
- Operating Instructions 11
- Warranty 12

SERVICE GUIDE

- Service Requirements 13
- Hot Tank Principles of Operation..... 14
- Resetting the Hot Tank Overload (High Limit Safety) 15
- Hot Tank Descaling..... 16
- Firewall™ Outlet Solenoid – Reverse Flow Orientation 18
- Adjusting Cold Water Set Point 19
- Programming – Disabling Energy Saving Sleep Mode 20
- Replacement Components (Consumables) 21
- Counter Top Drawings and Parts List..... 22
- Tower Drawings and Parts List..... 27
- Counter Top Flow Diagram 33
- Tower Flow Diagram 34
- Electrical Schematic 35

INSTALLATION GUIDE

- Pre-Installation Procedures 36
- Countertop Draining Procedure 40
- Tower Draining Procedure 41
- Installation Instructions 43

TROUBLESHOOTING GUIDE

- Fault Codes..... 45
- Power Troubleshooting..... 49
- Dispense Troubleshooting 52
- Cold Water Troubleshooting..... 68
- Hot Water Troubleshooting..... 69



SAFETY ALERT SYMBOLS

Read and follow all safety information carefully. The signal words used in this manual are selected as shown below and based on an assessment of the degree of potential injury or damage (severe or minor) and the occurrence of injury (definitely occurs or has the potential to occur) when the warning is ignored:

⚠ DANGER!

Indicates a situation which, when not avoided, results in death or severe injury.

⚠ WARNING!

Indicates a situation which, when not avoided, has the potential to result in death or severe injury; and/or severe property damage.

⚠ CAUTION!

Indicates a situation which, when not avoided, results or has the potential to result in minor injury; and/or minor property damage.

SAFETY PRECAUTIONS

Basic safety precautions should be followed, including the following:

Ensure all Local, State, and Federal Laws and Codes including health and safety guidelines are met when installing **Waterlogic** Equipment. Only qualified service technicians should attempt installation and service of **Waterlogic** Equipment. Always read the entire operating instructions before using the appliance and save these instructions for future use.

⚠ DANGER! *This product can cause death or severe injury if incorrectly operated, installed or maintained. The installation, maintenance, sanitizing and any repair must be performed by qualified persons trained by Waterlogic International or their approved distributors only. Do not remove any panel or cover to protect against electrical shock and exposure to UV radiation.*

⚠ DANGER! ELECTRICAL SHOCK HAZARD. *Always use a dedicated and properly grounded outlet. Unit should be protected by ground-fault circuit interrupter (GFCI) or residual current device (RCD) having a rated residual operating current not exceeding 30mA. Use only Waterlogic supplied power cord. Never use extension cords or power strips to connect unit. Do not use if the power supply cord is damaged. Always unplug from power supply prior to servicing.*

⚠ WARNING! AUTHORIZED USE ONLY. *This appliance is to be used for its intended purpose as described in this manual and untrained individuals who use this manual assume the risk of any resulting property damage or personal injury. This appliance can't be used by children and persons with reduced physical, sensory or mental capabilities or lack of experience.*

⚠ WARNING! UV-C EMITTER (UV LAMP). *This appliance contains a UV-C emitter (UV Lamp). UV-C radiation may, even in little doses, cause harm to the eyes and skin. Unintended use or damage to the housing may result in the escape of dangerous UV-C radiation. Never operate the UV-C emitter if damaged or removed from enclosure. Do not touch or look directly into the faucet.*

- ⚠ WARNING! DO NOT OPERATE IF DAMAGED.** *Unplug and isolate water supply if abnormal conditions exist. Contact Waterlogic or authorized dealer for repair, service, and installation to avoid hazards.*
- ⚠ WARNING! HOT WATER.** *Unit produces Hot Water in excess of 80°C (175°F). Water above 52°C (125°F) can cause severe burns or scalding. Keep unauthorized people and children away from the unit to avoid accidental dispensing of hot water.*
- ⚠ WARNING! CONNECT TO POTABLE WATER SUPPLY.** *This system is to be used for water only and is not intended for use where water is microbiologically unsafe or with water of unknown quality without adequate disinfection before or after the system.*
- ⚠ WARNING! TIP HAZARD.** *Dispenser could tip or fall causing serious injury. Always install unit on a firm, flat, and level surface and secure unit to cabinet, wall, or floor if needed. Never place heavy items on top of unit and never climb, stand, or hang on unit or storage cabinet to prevent injury and damage.*
- ⚠ WARNING! UNIT IS HEAVY. TWO PERSON LIFT REQUIRED.** *Transport unit empty and always use material handling equipment or two people with proper lifting technique to reduce injury risk.*
- ⚠ WARNING! STORE AND TRANSPORT UNIT EMPTY. ALWAYS SANITIZE BEFORE USE.** *The unit must be completely drained before storing to avoid stagnation and reduce microbiological contamination (potential bacterial growth). Always sanitize before use to eliminate any potential microbiological contaminants.*
- ⚠ CAUTION! INDOOR USE ONLY.** *Intended for Household Use. Never expose to direct sunlight, heat sources, or ambient air temperature above 37°C (100°F) or below 2°C (35°F). Install indoors and keep unit away from excessive humidity. Never expose to freezing temperatures. Ensure there is adequate clearance around the unit to allow refrigeration system condenser to dissipate heat. Warmer environments require more clearance around the unit. Minimum clearance around all surfaces of the machine is 2-inches. Installs where the ambient temperature exceeds 27°C (80°F), require a minimum of 4-inches clearance for proper heat dissipation and efficient operation.*
- ⚠ CAUTION! USE A WATER PRESSURE REGULATOR.** *Waterlogic will not be responsible for injury or damage caused by excessive water pressure. Input or feed pressure must be 40 psi to 60 psi. Be aware of any potential pressure surges caused by building/municipal pumping stations.*
- ⚠ CAUTION! USE UV STABILIZED SUPPLY LINES.** *Feed the unit with a potable ambient or cold water supply only. Feed water over 37°C (100°F) can damage the treatment components. Water block devices and external leak detectors are strongly recommended. Locate the unit as close to the water supply and the electrical connections as possible. Locate the unit as close to the water supply and the electrical connections as possible. Immediately isolate or close water supply valve and contact service representative if leak is noticed.*

Contact Waterlogic for assistance or help finding an Authorized Service Representative.

WL2FL FEATURES AND BENEFITS

Cold and Hot Water

Cold and Hot Selections to meet a wide range of customer demands.

High Volume Storage and Water Capacity

Tower Model has 4 liters (1 gallon) of Cold Water Capacity and 1.6 Liters (.43 gallons) of Hot Water. Counter Top has 2 liters (½ gallon) of Cold Water Capacity and 1.6 Liters (.43 gallons) of Hot Water.

BioCote® Anti-Microbial Protection

Certain plastic, silicon, and painted surfaces surrounding the dispensing areas and drip tray are infused with an exclusive additive called BioCote®. BioCote® provides an effective barrier against microbes like bacteria and mold, which may cause odors or staining.



Large Dispense Area with Recessed Faucet

8.5 inch dispense height with BioCote® recessed faucet to protect from cross-contamination.

Leak Prevention

WL2FL Water Treatment Systems are supplied with an extra solenoid to provide redundant protection and reduce accident potential

Child Safeguard

WL2FL Water Treatment Systems requires Hot Water selection followed by main dispense for Hot Water, and defaults back to cold selection after 3 seconds of inactivity to prevent accidental dispensing of hot water.

Energy Saving Sleep Mode

Energy Saving Sleep Mode turns off the Hot Tank when no Hot Water is dispensed for 3 hours. Touching the Hot Dispense Button turn the Hot Tank back on. The Energy Saving Sleep Mode can be programmed to be disabled.

Firewall™

Firewall™ is proprietary technology that places the UV lamp at the point of dispense. This point of dispense purification keeps the dispense nozzle free from external contamination as well as purifying the water, making the freshest water possible.



Auxiliary Port

Auxiliary Port to feed Coffee Machines or other Appliances on Counter Top Models.

WL2FL CERTIFICATIONS

Conformance Statement: The WL2FL has been tested and certified by IAPMO R&T to NSF/ANSI 42 for the reduction of chlorine, taste, and odor; NSF/ANSI 53 for the reduction of lead, cyst, and asbestos (using replacement filter FT-0063-IL, and FT-0064 replacement element); NSF/ANSI 55-Class A disinfection; NSF P231 for the reduction of cyst, bacteria, and virus; US EPA Guide Standard and Protocol for the reduction of cyst, bacteria, and virus.

WL2FL Water Treatment System Certifications Include:



NSF/ANSI-55 Class A –Ultraviolet Microbiological Water Treatment Systems

Firewall™ Technology contains our latest, most innovative and patented breakthrough, “The Firewall™”, the most comprehensive UV purification system for point-of-use water treatment systems ever developed. The Waterlogic Firewall™ component has been certified by IAPMO R&T to NSF/ANSI-55 Class A – Ultraviolet Microbiological Water Treatment Systems.

This Class A system conforms to NSF/ANSI 55 for the disinfection of microbiologically contaminated water that meets all other public health standards. The system is not intended to convert wastewater or raw sewage to drinking water. The system is intended to be installed on visually clear water. NSF/ANSI 55 defines wastewater to include human and/or animal body waste, toilet paper, and any other material intended to be deposited in a receptacle designed to receive urine and/or feces (blackwaste), and other waste materials deposited in plumbing fixtures (greywaste).

NSF P231/US EPA Guide Standard and Protocol for Microbiological Purifiers

The Public Health and Safety Organization establishes minimum requirements for health and sanitation characteristics of microbiological water purifiers. The requirements are based on the recommendations of the U.S. Environmental Protection Agency's Task Force Report.

NSF/ANSI-42 – Chlorine, Taste and Odor Reduction

NSF/ANSI-53 – Lead, Cyst, and Asbestos Reduction

The Public Health and Safety Organization establishes minimum requirements for materials, design, construction, and performance of drinking water treatment units that are designed to reduce specific aesthetic-related contaminants in public or private water supplies.

Note: The WL2FL contains the FT-0063-IL one-micron CBC filter (including FT-0064 filter element) certified to NSF/ANSI 42 for Chlorine, Taste, and Odor Reduction, and NSF/ANSI-53 Lead, Cyst, and Asbestos reduction. This filter must remain installed in the WL2FL to maintain these certifications.



UL399 – Certified Drinking Water Cooler

Intertek Labs (ETL) Certified the **WL2FL Water Treatment System** to ANSI/UL 399 Standard for Drinking Water Coolers.



BPA Free - **Waterlogic** tests for BPA and declares that all of its products are Bisphenol-A FREE and contain no harmful BPA plastics.

Waterlogic is certified to ISO 9001:2015 – Quality Management Systems (certified by Intertek). ISO 9001 is the internationally accepted standard for well managed organizations that have adopted the key quality management principles to its operations to bring consistent quality products and a culture of continuous improvement.



Safe Drinking Water Act

Waterlogic water treatment systems conform to the Safe Drinking Water Act (SWDA) “lead-free” amendment effective January 4, 2014. The WL2FL Systems are certified to NSF/ANSI 372.

MODEL/PART DESIGNATIONS

BRAND NAME	DESCRIPTION	MODEL – PART NUMBER
WL2FL-FZ Counter Top	Waterlogic WL2FL-FZ Counter Top – Cold/Hot	WL2MFL-FZ-HC
	F-2FZFL-M-HC-TS-BS-LIN Serial Number Prefix: LG2H2BS	
WL2FL-FZ Tower	Waterlogic WL2FL-FZ Tower – Cold/Hot	WL2FL-FZ-HC
	F-2FZFL-FS-HC-TS-BS-LIN Serial Number Prefix: LG1H2BS	
WL2FL-FX Counter Top	Waterlogic WL2FL-FX Counter Top – Cold/Hot	WL2MFL-FX-HC
	F-2FXFL-M-HC-TS-BS-WLU Serial Number Prefix: LE2H221BS	
WL2FL-FX Tower	Waterlogic WL2FL Tower - Cold and Hot	WL2FL-FX-HC
	F-2FXFL-FS-HC-TS-BS-WLU Serial Number Prefix: LE1H221BS	

SPECIFICATIONS

ITEM	WL2FL Counter Top	WL2FL Tower
Water Connection	¼" Quick Connect	
Cold Water Temperature	Cold Water Temperature – Factory Set Point 5°C (41°F) Adjustable to 1.1°- 12.2°C (34° - 54° F)	
Cold Tank Size	Countertop - 2 Liters (0.53 Gallons) Tower – 4 Liters (1 Gallon)	
Hot Water Temperature	87°C (187°F) Thermistor Control Hot Tank	
Hot Tank Size	1.6 Liters (.42 Gallons)	
Hot Water Manual Reset Overload	105°C (221°F)	
Recommended Incoming Feed Pressure & Flow	Pressure 40-60 psi (275-414 kPa) – Use Pressure Regulator Input Flowrate 2 – 4 Liters per Minute (0.5 – 1.0 gpm)	
Maximum Service Pressure	100 psi (689 kPa) – Use Pressure Regulator when pressure is over 60 psi	
Rated Service Flow Out	1.6 Liters per Minute (0.42 Gallons per Minute) – Firewall™ Purification	
Environmental Temperature	2°- 37°C (35°- 100°F) Do not use Outdoors	
UV Lamp	15 Watts	15 Watts
Heater	500 W	
Refrigerant Gas	R134a, 38g, 1.59 ounces	R134a, 38g, 1.76 ounces
R134a Pressures	High (280 psi), Low (90 psi)	

SHIPPING SPECIFICATIONS

<u>ITEM</u>	<u>WL2FL Counter Top</u>	<u>WL2FL Tower</u>
Width/Depth/Height	35cm x 37cm x 45cm 13.75" x 14.25" x 17.87" #	35cm x 37cm x 104cm 13.75" x 14.25 x 41"
Weight (dry) Unit Only	26.3 kg (58 pounds)	30.0 kg (66 pounds)

ELECTRICAL SPECIFICATIONS

<u>ELECTRICAL SUPPLY</u>	<u>120V/60Hz</u>	<u>15 Amp Service</u>
<u>COMPONENT</u>	<u>POWER (approximate)</u>	<u>AMP DRAW (approximate)</u>
Heater	504	4.2 Amps
Compressor	168	1.4 Amps
UV Lamp System	36	0.3Amps
WL2FL TOTAL	708	5.9 Amps



#WL2FL Counter Top is 17.875 in. tall always check installation to ensure adequate clearance between countertop and cabinets.

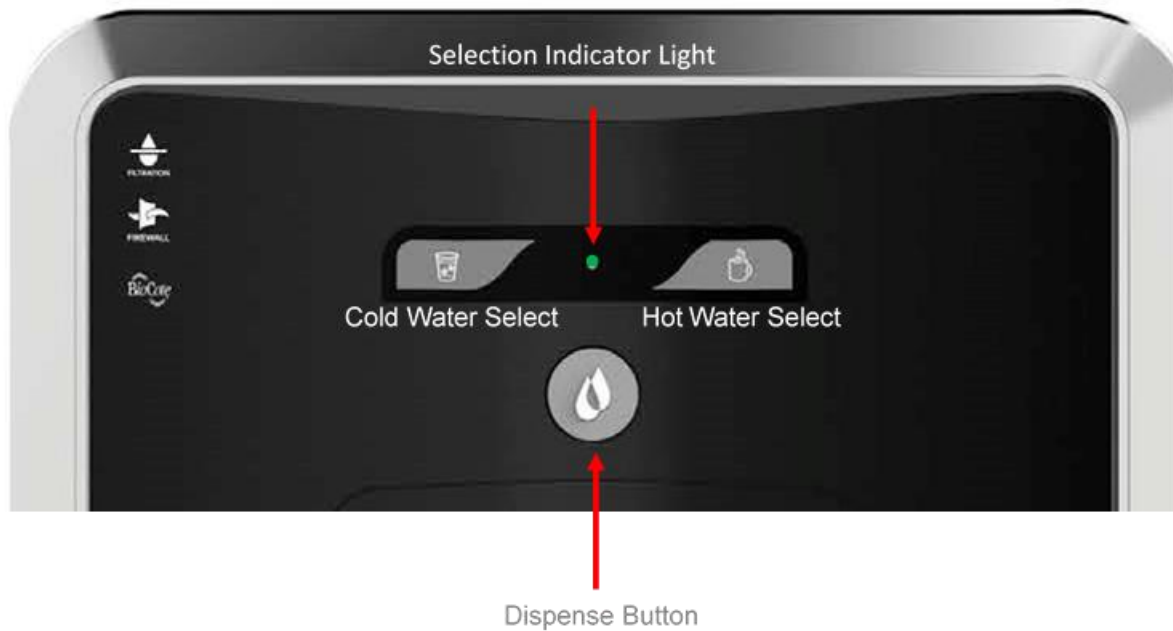

OPERATING INSTRUCTIONS



The above picture shows front LCD display and control panel for the **Waterlogic WL2FL Water Treatment System**.

	Cold Water	Press Cold Water Select Button followed by the Dispense Button (within 3 seconds) or; Press and Hold the Dispense Button (Cold Water is the default water selection).
	Hot Water	Press Hot Water Select Button and release, then Press and Hold the same button. Hot Water will dispense after a brief delay.

NOTE: Default selection mode is Cold Water. Selection will return to default after 3 seconds of inactivity.

NOTE: Selection indication light will turn Red when the Hot Water Select Button is pressed and will switch back to the default Cold within 3 seconds after dispensing the Hot Water.

NOTE: The indicator light turns Orange when the heater is active and will return to green once the hot set point is reached.



WATERLOGIC MANUFACTURED WATER TREATMENT SYSTEM LIMITED WARRANTY **UNITED STATES AND CANADA ONLY**

Waterlogic water treatment systems are guaranteed to the original purchaser to be free of defects in materials and workmanship for a period of three (3) years from the date of purchase, but in no event longer than forty-eight (48) months from the date of manufacture. Waterlogic Commercial Products, LLC (“Waterlogic”) based in the U.S.A. and its affiliated companies are not liable for any cost of removal, installation, transportation, or any other charges which may arise in connection with a warranty claim.

This warranty does not cover damage or wear to products caused by abnormal operating conditions, accident, abuse, misuse, unauthorized or improper alteration or repair, damage caused by or resulting from shipping or accident, damage caused by hot water, freezing, flood, fire, or acts of God. The effects from chlorine corrosion, scaling and normal wear are specifically excluded from this warranty. This warranty does not cover products used outside the countries where the unit was purchased, and does not cover products that were not installed in accordance with Waterlogic printed installation and operating instructions obtained in training or from www.waterlogic.us. Failure to follow all instructions for operation and maintenance voids the warranty. This warranty is not transferable.

To obtain warranty repairs or replacement, you must obtain a Return Authorization from Waterlogic. To obtain a Return Authorization, you must submit a Return Authorization form with supporting documentation to Waterlogic for evaluation. The form is available at www.waterlogic.us. Supporting documentation must include, but is not limited to; proof of purchase, installation date, failure date, and supporting installation and maintenance data. After you submit a Return Authorization form and supporting documentation, Waterlogic will determine whether a reasonably apparent defect in materials or workmanship covered by this limited warranty exists. If Waterlogic determines the claimed defect is covered by this warranty, Waterlogic will, at its sole discretion, determine whether to correct the defect or replace the unit, free of charge to you. If Waterlogic determines that the unit should be returned for warranty service, Waterlogic will approve of return in writing and will issue a Return Authorization which you must obtain prior to shipping the product. You are responsible for the cost of freight in to Waterlogic.

Waterlogic and its affiliated companies hereby limit the duration of any and all implied warranties to a maximum period of three (3) years from the date of purchase including, but not limited to, the implied warranties of merchantability and fitness for a particular purpose. Some states do not allow limitations on how long an implied warranty lasts, so the above limitation may not apply to you. Consequential and incidental damages are not recoverable under this warranty. Some states do not allow the exclusion or limitation of incidental or consequential damages, so the above limitation or exclusion may not apply to you.

This warranty gives you specific legal rights and you may also have other rights which may vary from state to state.

New Warranty Policy issued by Waterlogic Commercial Products LLC, USA - January 10, 2014

Waterlogic Commercials Products LLC
3175 Bass Pro Drive
Grapevine, TX 76051

Tel: (800) 288-1891
Website: waterlogic.com/en-us/

SERVICE REQUIREMENTS

⚠ WARNING! *Read and understand the contents of this manual before attempting to service WL2FL Water Treatment System. Failure to follow the instructions in this manual could result in death, serious personal injury, or severe property damage. Only trained and qualified technicians should attempt to install, maintain, or service Waterlogic Equipment.*

1. Visually inspect all electrical and water connections for signs of wear or damage.

⚠ DANGER! ***HIGH VOLTAGE ELECTRICAL HAZARD.** Unplug before inspection and service.*

2. **Waterlogic** recommends changing the UV Lamp every 12 months.

⚠ WARNING! ***UV-C EMITTER (UV LAMP).** This appliance contains a UV-C emitter (UV Lamp). UV-C radiation may, even in little doses, cause harm to the eyes and skin. Unintended use or damage to the housing may result in the escape of dangerous UV-C radiation. Never operate the UV-C emitter if damaged or removed from enclosure. Do not touch or look directly into the faucet.*

⚠ CAUTION! ***UV LAMPS ARE HAZARDOUS.** Lamps are considered Hazardous Waste and must be disposed of accordingly. Refer to Product MSDS sheet for details.*

3. Clean the Spiral Quartz Spiral that surrounds the UV Lamp with a non-abrasive cloth, descaling solution, or ultrasonic bath if needed when changing UV Lamps.

⚠ CAUTION! ***UV SYSTEM IS FRAGILE.** Never handle the UV lamp or Quartz Spiral with bare hands. UV Lamp and quartz spiral must be free of oils and contaminants to ensure proper operation. Use a soft non-abrasive cloth to clean.*

4. Sanitize the Cold Tank per instructions in the pre-installation procedures.

5. Clean and sanitize external surfaces of the unit. Use soap and water or chemicals that are compatible with ABS plastic and will not damage or degrade the product surfaces.

6. Remove and clean the Faucet. Replace as needed.

⚠ WARNING! ***SANITIZER MAY CONTAIN HAZARDOUS CHEMICALS.** Use of proper personal protective equipment such as rubber gloves and eye protection is required.*

HOT TANK PRINCIPLES OF OPERATION

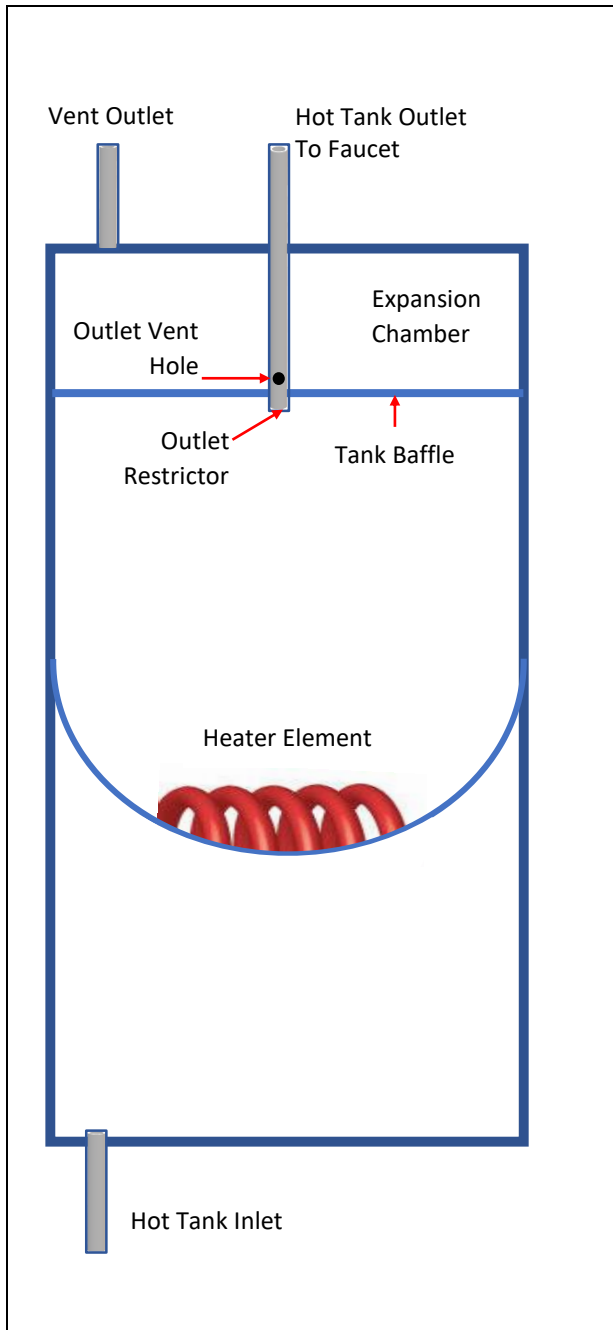

All **Waterlogic** Hot Tanks have a built-in Vent or Expansion Chamber in the top of the tank except for WL270 (GF) units.

The Vent Chamber allows for expansion of the water when it is heated.

The chambers are separated by a welded-in tank baffle.

Water always flows into the bottom of the tank and out the top to the faucet.

The hot tank outlet tube has a restrictor in its base. This ensures the reservoir is always full by allowing more water in than out.

There is a small hole in the side of the tank outlet tube that allows air and water to pass into the vent chamber as it is heated.

Water in the vent chamber is suctioned back through the outlet tube vent hole when water is dispensed.





Expansion of water as it is heated in the reservoir will push the water out the faucet when the outlet tube vent hole becomes plugged with debris or scale.

The small Outlet Vent Hole is susceptible to scale build up and is a key indicator that descaling is required.

It is critical to descale the hot tank through the vent line and outlet line on a regular basis to prevent this problem.

Descaling through the inlet and/or outlet lines only will not clean the vent chamber and outlet vent hole properly.

RESETTING THE HOT TANK OVERLOAD OR HIGH LIMIT SAFETY

1.	Red Compressor/Heater Switch must be in the <i>O=OFF</i> position	
2.	Unplug the Power Cord from rear of WL2FL Water Treatment System .	
3.	Remove the Side Panel by removing the Front Hatch and Side Panels.	
4.	Locate the Hot Tank	
5.	Press the Reset Button	
6.	Replace the Lower Front Panel.	
7.	Plug in the Power Cord.	
8.	Turn on the Red Compressor / Heater Switch <i>I=ON</i> position The Hot and Cold Tanks must be filled with water BEFORE turning on the Red Heater and Compressor Switch.	
9.	Verify the cooler is fully operational before installing it at the customers' site.	

HOT TANK DESCALING INSTRUCTIONS

The Hot Tank requires removal of mineral deposits (descaling) on a regular basis. Typically descaling should take place every 6 to 12 months to preserve the long-term health of your unit.

Use non-toxic cleaner such as ScaleKleen, DEZCAL, 20% Citric Acid Solution, or Undiluted Vinegar Solution to remove mineral deposits as directed by the manufacturer depending upon filtration and local water conditions.

Descaling is an important process that removes calcium deposits, or scale, that can build up inside a tank over time. Calcium and scale are non-toxic but left unattended will hinder your unit's performance.

⚠️ WARNING! ***PERSONAL PROTECTIVE EQUIPMENT REQUIRED.** Always ensure proper ventilation and use rubber or nitrile gloves and eye protection when using chemicals. Refer to Material Safety Data Sheet for specific requirements of each product.*

⚠️ CAUTION! ***STAINLESS STEEL TANK DESCALING.** The Hot Tank is made from stainless steel. Ensure descaling solution is compatible with stainless and always flush the unit completely. Dispose in an environmentally safe manner.*

Materials Needed:

- Personal Protective Equipment. Rubber or Nitrile Safety Gloves and Protective Eyewear
 - Phillips Screwdriver
 - Temperature Gauge
 - Water Pitcher or Container to collect water from the faucet
 - 19 Liter (5 gallon) container or drain basin
 - Citric Acid Based Cleaner
 - ¼" Plastic Tubing, at least 4 feet in length, and assorted ¼" quick connect fittings
 - Sanitizing Cartridge
 - Food Coloring
1. Put descaler per directions and 3 drops of food coloring into the descaling cartridge.
 2. Connect descaling cartridge to the inlet water supply and connect to Inlet Bulkhead Fitting on the back of the **WL2FL Water Treatment System**. Turn on Water Supply.
 3. Select Hot Water and depress the Main Dispensing Button on the Front Control Panel until descaling solution (colored water) comes out of the faucet. Container and drain basic will be required to catch water from the faucet.
 4. Turn off water supply and remove sanitizing cartridge from inlet water supply. Reconnect water supply to inlet fitting.

5. Allow descaling solution to remain in the Hot Tank for 15 minutes (length of time may vary depending on water conditions).
6. Place a pitcher, catch basin or other container under the faucet of the **WL2FL Water Treatment System**.
7. Flush the Hot Tank until water runs clear.
8. Once clear Water dispenses from the faucet the Hot Tank has been descaled. Always ensure the **WL2FL Water Treatment System** is performing to the customer's satisfaction.

⚠ WARNING! HOT WATER. *The WL2FL Water Treatment System produces Hot Water up to 86°C (187°F). Water above 52°C (125°F) can cause severe burns or scalding. Hot water should be dispensed carefully into insulated container to avoid injury.*

⚠ CAUTION! MUST REPLACE HOT TANK 3-5 YEARS DEPENDING ON USAGE. *The Hot Tank and its controls must be replaced a minimum of every three to five years to ensure efficient and dependable operation.*

⚠ WARNING! REINSTALL ALL PANELS AND COVERS. *Always reinstall all Panels, Protective Covers, and Fasteners after servicing equipment. Failure to do so could result in severe personal injury and will void the certifications and warranty of the equipment.*

FIREWALL™ OUTLET SOLENOID – REVERSE FLOW ORIENTATION

Firewall Outlet Solenoid – Reverse Flow Orientation

Firewall outlet solenoid must be installed backwards or reverse flow to allow water expansion bypass and prevent over pressure and bursting of the cold tank.

Solenoid Flow Indicator shown should point toward cold tank as shown below:

Flow
Indicator
Arrow

Firewall Inlet

Cold Tank Outlet

Water flows from cold tank outlet to cold outlet solenoid then to Firewall UV Purification at point of dispense. Shown by blue flow lines above.

ADJUSTING COLD SET POINT

Cold Water Temperature – Factory Set Point is 41°F (5°C) and can be adjusted to 34°F - 54°F (1.1°C to 12.2°C)

The cold set point can be adjusted by accessing the cold thermostat adjustment screw under the decal at the rear of the unit.



Remove the red portion of the Cold Tank Temperature label to access the adjustment screw.

The factory set point is ~41°F and is indicated by the dot on sheet metal.



Turning the adjustment screw clockwise to lower the set point temperature.

Do not adjust past the “Max Cold” position at 3:00 position to avoid freezing the cold tank.



Turning the adjustment screw counter-clockwise to raise the set point temperature.

PROGRAMMING INSTRUCTIONS

DISABLING ENERGY SAVING SLEEP MODE

All **WL2FL Water Treatment Systems** come from the factory with Energy Saving Sleep Mode engaged to meet the Energy Star Certification requirements. Energy Saving Sleep Mode disables the heater circuit if the unit has not been used for a continuous 3 hour or longer period. Selecting any button "wakes up" the **WL2FL Water Treatment System** and turns the heater circuit back on. The hot tank will typically take less than 10 minutes to heat the water from ambient to the 85°C (185°F) set point.

Unplug Power Cord and remove Top Cover to access back side of the Display PCB.

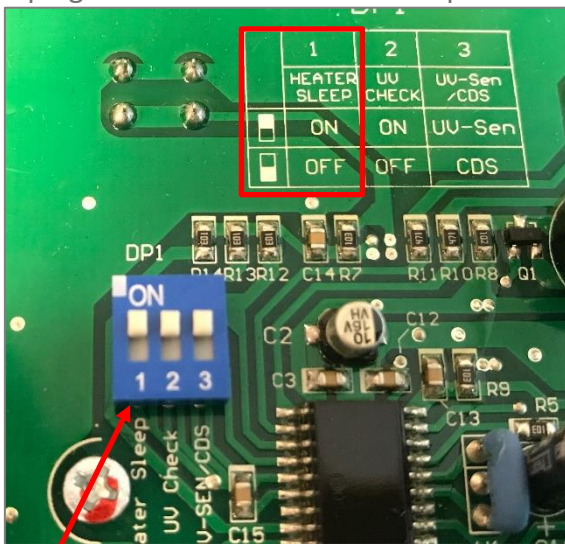

WL2FL Water Treatment Systems comes with the Energy Saving Sleep Mode "ON" - the Default Position.

DIP 1 in the "ON" position (up).

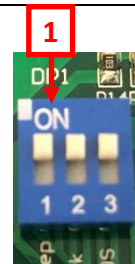

Deactivate the Energy Saving Sleep Mode by moving DIP 1 in the "OFF" position (down).

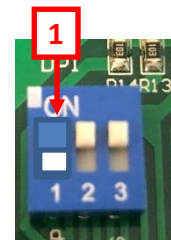

REPLACEMENT COMPONENTS - CONSUMABLES

Component	WLCP PN	Frequency of Replacement
15W X UV Lamp Assembly	12-8310	Every 12 months, or as required Factory Part No CT-2085-IA0-00
Hot Tank 120V/500W - 1.6L with Thermistor	10-4029	Replace every 3 to 5 years depending on usage. Factory Part No HT-3024
Sediment Filter - 10" 20 Micron Inline Filter	FT-0053-IL containing FT-0055 Filter Element	Every 12 months or every 1,250 gallons. Factory Part No FT-0053-IL Assembly containing FT-0055-WLT Filter Element
1-micron 10" Inline CBC Filter for CTO, Lead, Cyst and Asbestos Reduction (Carbon Block) NSF 53 Required for NSF Certification	FT-0063-IL containing FT-0064 Filter Element	Every 12 months or every 1,250 gallons. Factory Part No FT-0063-IL Assembly containing FT-0064-WLT Filter Element
10-micron 10" Inline GAC Filter for Taste and Odor Reduction (Grannual Activated Carbon) NSF 42 Required for NSF Certification	FT-0035-IL containing FT-0038 Filter Element	Every 12 months or every 1,250 gallons. Factory Part No FT-0035-IL Assembly containing FT-0038-WLT Filter Element

* One pre-installed. One required for NSF-42 / NSF-53 Certification.

⚠ CAUTION! Use only Waterlogic Replacement parts that can be obtained from *Waterlogic* or an *Authorized Waterlogic Dealer*, failure to do so will void the Warranty.

See **Installation and Service Manual** for additional information.

Hot Tank Service

Hot Tanks (with controls) must be replaced at least every 3-5 years depending on usage. Descaling hot tank may be required on a regular basis depending upon filtration and local water conditions. See Installation and Service Manual for further details.

Surface Cleaning

Clean on a regular basis with damp lint free cloth. Never use harsh chemicals (alcohol or acid based) or abrasive agents on any part of the product to avoid damage. A mild cleaner such as Simple Green or equivalent is recommended.

DISPOSAL

End of Life

At the **end of this product's life**, ensure that it is disposed of in an environmentally friendly manner which is fully compliant **with all Federal/State/Local Requirements and Guidelines**. Do not dispose of this appliance with normal household or business waste.

WL2MFL COUNTER TOP LAYOUT DRAWING AND PARTS LIST

Yellow = Consumables
 Green = Recommended spare parts

Wetted Parts

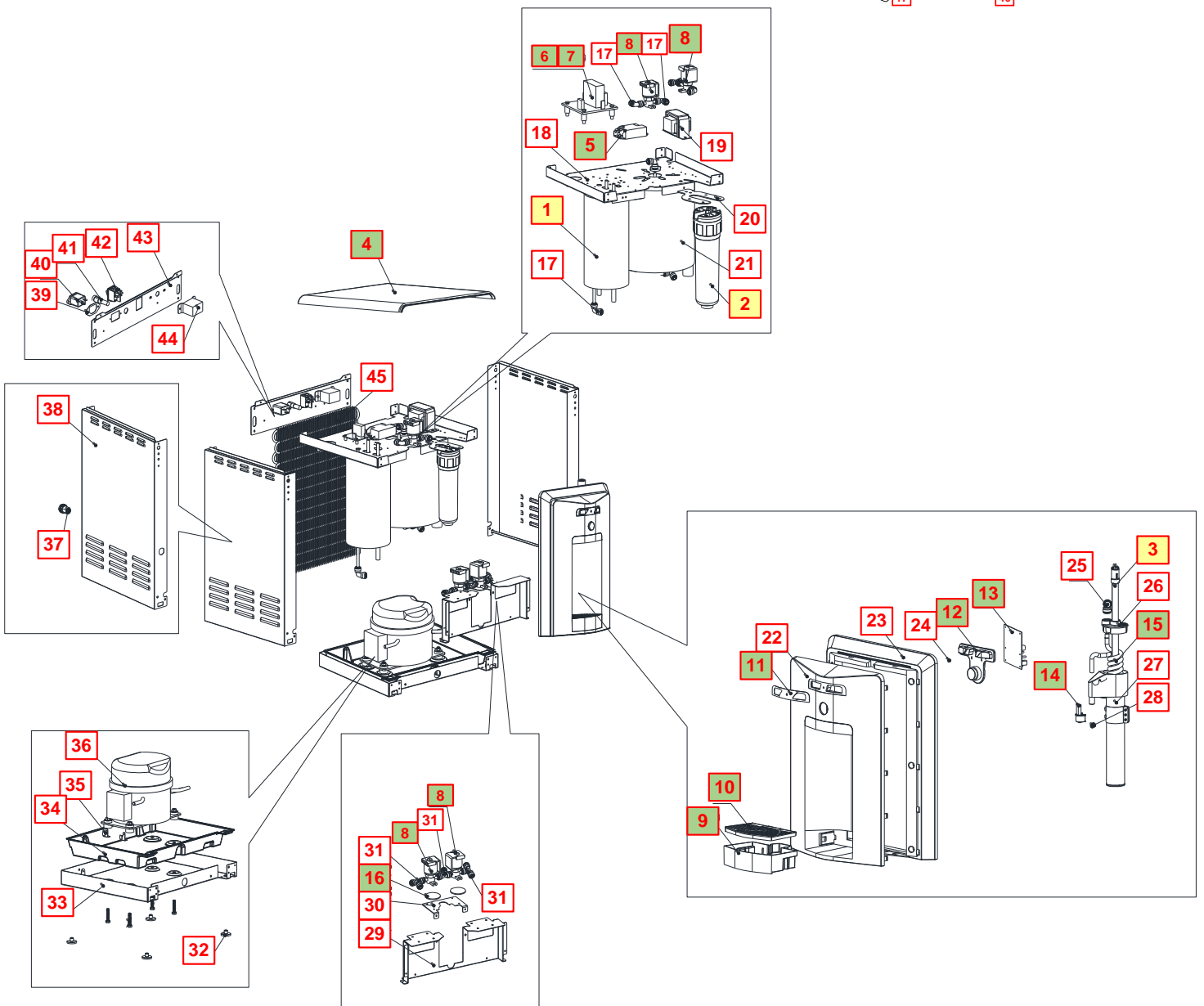
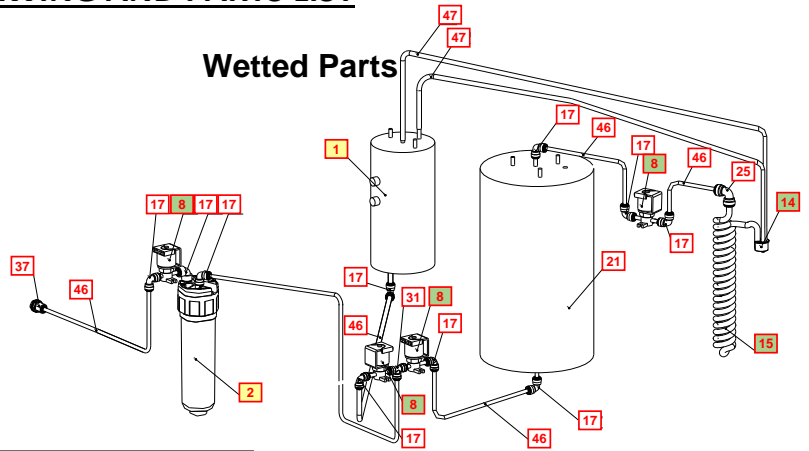





No	WLUSA Part Number	Description	Factory Part Number	Stocked?	
Consumables					
1	10-4029	Hot Tank 120V/500W - 1.6L with Thermistor	HT-3024	Yes	
2	FT-0063	1-micron 10" Inline CBC Filter for CTO, Lead, Cyst and Asbestos Reduction (Carbon Block) - Filter Element FT-0064 for replacement cartridge	FT-0063-IL-WLT	Yes	
3	12-8310	15W X UV Lamp Assembly	CT-2085-IA0-00	Yes	
Not shown	01-2076	Scale Kleen	NA	Yes	
Recommended Spare Parts					
1.1	12-1360	Overload with Manual reset - 221°F (105°C) <i>Recommend stocking 2 each per 10 units purchased</i>	HT-3012	Yes	
1.2	12-6900	Overload Metal Cover <i>Recommend stocking 2 each per 10 units purchased</i>	ST-8290	Yes	
4	PL-0191-L00-BL	Black Top Cover <i>Recommend stocking 2 each per 10 units purchased</i>	PL-0191-L00-BL	Yes	
4.1	ST-0049-L00-00	High Voltage Metal Cover (ETL Certification) – Under Top Cover <i>Recommend stocking 2 each per 10 units purchased</i>	ST-0049-L00-00	Yes	
5	EN-0008-LA1-00	13W / 15W 120V / 60Hz Electronic FX Ballast <i>Recommend stocking 2 each per 10 units purchased</i>	EN-0008-LA1-00	Yes	
6	EN-6134	Main PCB <i>Recommend stocking 2 each per 10 units purchased</i>	EN-6134	Yes	
7	10-3017	Plastic PCB Support <i>Recommend stocking 2 each per 10 units purchased</i>	EN-6059	Yes	
8	PU-4017	Solenoid Valve DC24V 500mm <i>Recommend stocking 2 each per 10 units purchased</i>	PU-4017	Yes	
9	PL-0194-L00-BL	Black Drip Tray Body <i>Recommend stocking 4 each per 10 units purchased</i>	PL-0194-L00-BL	Yes	
10	PL-0195-L00-BL	Black Drip Tray Grill <i>Recommend stocking 4 each per 10 units purchased</i>	PL-01 95-L00-BL	Yes	
11	LP-0422-L00-00	Hot and Cold User Interface Label <i>Recommend stocking 2 each per 10 units purchased</i>	LP-0422-L00-00	Yes	

12	PL-0199-L00-00	Hot and Cold Dispense Silicon Button Mat <i>Recommend stocking 2 each per 10 units purchased</i>	PL-0199-L00-00	Yes	
13	EN-0078-L00-00	Display PCB <i>Recommend stocking 2 each per 10 units purchased</i>	EN-0078-L00-00	Yes	
14	12-8370	Hot Water Faucet <i>Recommend stocking 2 each per 10 units purchased</i>	PL-1351	Yes	
14.1	10-3048	Faucet Nipple – Blue with Screen <i>Recommend stocking 2 each per 10 units purchased</i>	PL-1013	Yes	
14.2	10-2600	Silicon Faucet O-ring <i>Recommend stocking 2 each per 10 units purchased</i>	CT-2007	Yes	
15	12-8305	Quartz Spiral UV Faucet <i>Recommend stocking 2 each per 10 units purchased</i>	FU-0007	Yes	
16	CU-0001	Solenoid Cushion <i>Recommend stocking 2 each per 10 units purchased</i>	CU-0001	Yes	
Remainder of Parts					
1.2	NA	Hot Tank Thermistor	HT-3002	No	
17	Purchase from John Guest	JG Equal Elbow Connector 1/4" John Guest P/N PI0308S	PU-4008	No	
18	NA	Upper Shelf	ST-0198-L00-00	No	
19	12-8375	Transformer 1.6A / 120 V	EL-5147	Yes	
20	NA	Inline Filter Bracket	ST-0200-L00-00	No	
21	NA	Cold Tank Assembly - 2Liter	CT-2060-B	No	
22	NA	Black Front Top Panel	PL-0202-L00-BL	No	
23	NA	Silver Front Top Panel Trim	PL-0192-L00-SI	No	
24	NA	LED Light Pipe	EL-0148-L00-00	No	

25	Purchase from John Guest	JG 3/8" x 1/4" Reducing Elbow (PI211208S)	PU-4137	No	
26	12-8320	Firewall UV Lamp Seal	CT-2088	Yes	
27	TBD	Firewall Housing	FW-0027-100-00	Yes	
28	AK-0064	UVC Sensor Assembly	AK-0064	Yes	
29	NA	Filter Bracket	ST-0199-L00-00	No	
30	NA	Firewall Bracket	ST-8297	No	
31	Purchase from John Guest	JG Equal Tee Connector 1/4" (PI0208S)	PU-4011	No	
32	12-3150	Unit Rubber Feet	PL-1251-CN	No	
33	12-3170	Bottom Tray	ST-8151	Yes	
34	NA	Leak Tray	PL-0198-L00-00	No	
35	12-3180	Leak Containment Tray Clip (sensor 0.5mm)	ST-8207-CN	No	

Verify compressor in machine before ordering parts as the Compressor P/N CO-0020-L00-00 and CO-0044-P00-00-LIN and related parts are not interchangeable.

CO-0020-L00-00 Compressor (WL2MFL-FX)

36A.1	CO-0020-L00-00	LG Compressor 120V R134A CSB035LJCM	CO-0020-L00-00	Yes	
36A.2	CO-0019-L00-00	Compressor Capacitor	CO-0019-L00-00	Yes	
36A.3	ST-0216-L00-00	Capacitor Bracket	ST-0216-L00-00	Yes	
36A.4	CO-0017-L00-00	PTC Relay	CO-0017-L00-00	Yes	
36A.5	CO-0018-L00-00	Overload Protector	CO-0018-L00-00	Yes	

CO-0044-P00-00-LIN Compressor (WL2MFL-FZ)					
36B.1	CO-0044-P00-00-LIN	Samsung Compressor (R134a 1/8HP) 120V/60Hz	CO-0044-P00-00-LIN	Yes	
36B.2		PTC & Overload Relay Combo		Yes	
36.1	12-1001	Filter Dryer	CO-9008	Yes	
37	10-3067	Bulkhead Union 1/4" x 1/4" John Guest P/N PI1208S	PU-4028	Yes	
38	ST-0205-L00-00	Side Panel	ST-0205-L00-00	Yes	
39	19-1015	Gasket for Power Socket	ST-8052	Yes	
40	19-1090	Power Line Noise Filter, Electromagnetic Interference filter (EMI)	EL-5029	Yes	
41	10-3014	Fuse Holder and Fuse 120V / 15A with One Wire	EL-5053	Yes	
41.1	10-3013	Fuse 120V / 15A	EL-5010	Yes	
42	12-5600	Red Heater and Compressor Switch	EL-5019-A	Yes	
43	ST-0204-L00-00	Back Panel	ST-0204-L00-00	No	
44	19-1069	Cold Tank Thermostat 3°C (37.4°F)	CT-2070-A	Yes	
44.1	LP-0326	Cold Thermostat Cover Label	LP-0326-L00-00	Yes	
45	12-3100	Wire Condenser	CO-9031	No	
46	Purchase from John Guest	JG LLD PE Tube - Blue O.D.1/4" John Guest P/N PE-08-BI-1000F-B	PU-4031	No	
47	10-7040	Silicon Tube 5/16" for hot water	PL-4064-L00-00	Yes	
Not Shown	10-3007	Power Cord 120V – 18240mm	EL-5001-B	Yes	

WL2FL TOWER LAYOUT DRAWING AND PARTS LIST

Yellow = Consumables

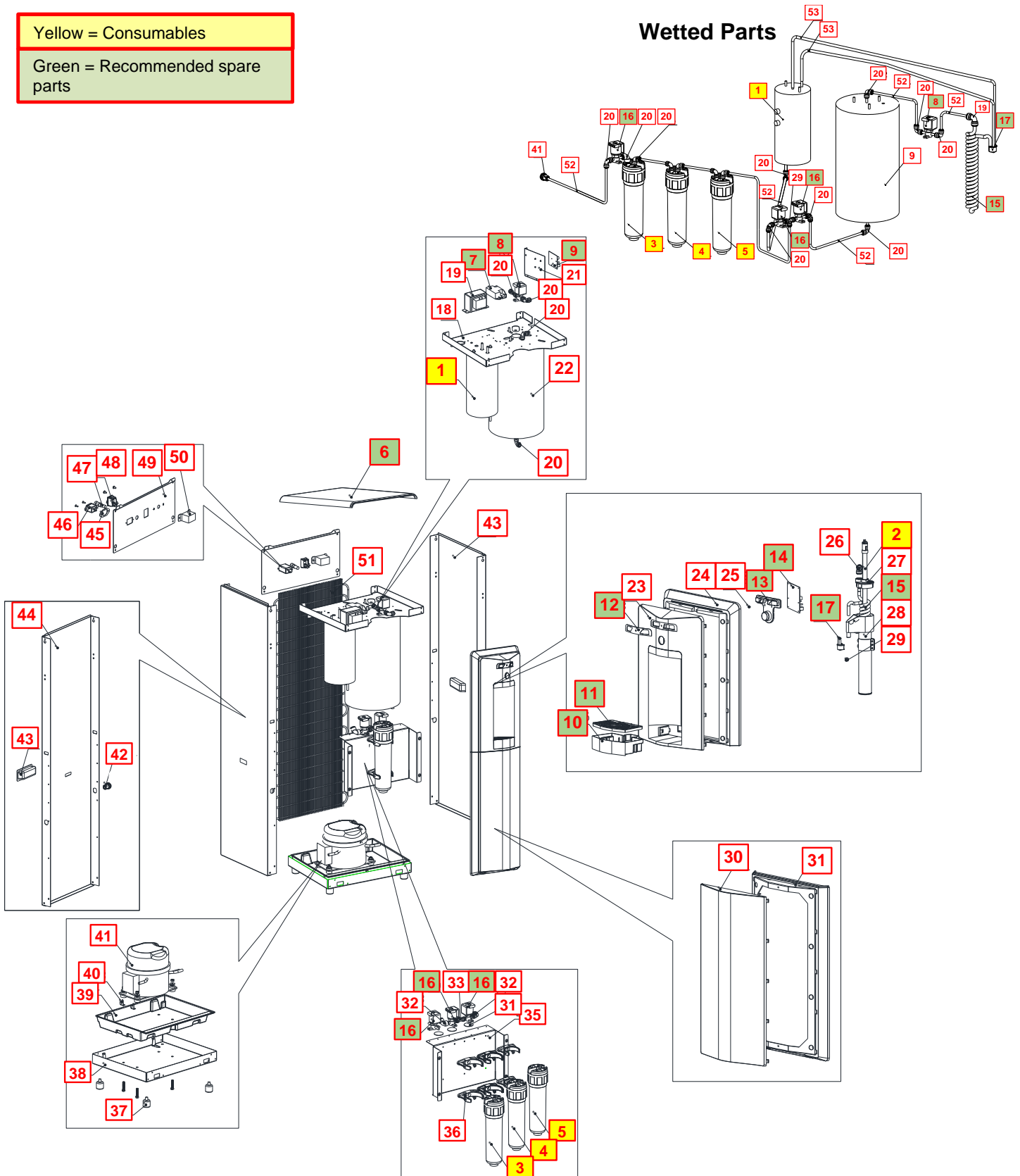

Green = Recommended spare parts



No	WLUSA Part Number	Description	Factory Part Number	Stocked?	
Consumables					
1	10-4029	Hot Tank 120V/500W - 1.6L with Thermistor	HT-3024	Yes	
2	12-8310	15W X UV Lamp Assembly	CT-2085-IA0-00	Yes	
3	FT-0035	GAC Filter - 10" Carbon Activated Inline Filter	FT-0035-IL-WLT	Yes	
4	FT-0053	Sediment Filter - 10" Sediment 20 Micron Inline Filter	FT-0053-IL-WLT	Yes	
5	FT-0063	1-micron 10" Inline CBC Filter for CTO, Lead, Cyst and Asbestos Reduction – Carbon Block	FT-0063-WLT	Yes	
Not shown	01-2076	Scale Kleen	NA	Yes	
Recommended Spare Parts					
1.1	12-1360	Overload with Manual reset - 221°F (105°C) <i>Recommend stocking 2 each per 10 units purchased</i>	HT-3012	Yes	
1.2	12-6900	Overload Metal Cover <i>Recommend stocking 2 each per 10 units purchased</i>	ST-8290	Yes	
6	PL-0191-L00-BL	Black Top Cover <i>Recommend stocking 2 each per 10 units purchased</i>	PL-0191-L00-BL	Yes	
7	EN-0008-LA1-00	13W / 15W 120V / 60Hz Electronic FX Ballast <i>Recommend stocking 2 each per 10 units purchased</i>	EN-0008-LA1-00	Yes	
8	PU-4017	Solenoid Valve DC24V 500mm <i>Recommend stocking 2 each per 10 units purchased</i>	PU-4017	Yes	
9	EN-6134	Main PCB <i>Recommend stocking 2 each per 10 units purchased</i>	EN-6134	Yes	
9.1	10-3017	Plastic PCB Support <i>Recommend stocking 2 each per 10 units purchased</i>	EN-6059	Yes	
10	PL-0194-L00-BL	Black Drip Tray Body <i>Recommend stocking 4 each per 10 units purchased</i>	PL-0194-L00-BL	Yes	
11	PL-0195-L00-BL	Black Drip Tray Grill <i>Recommend stocking 4 each per 10 units purchased</i>	PL-01 95-L00-BL	Yes	
12	LP-0422-L00-00	Hot and Cold User Interface Label <i>Recommend stocking 2 each per 10 units purchased</i>	LP-0422-L00-00	Yes	



13	PL-0199-L00-00	Hot and Cold Dispense Silicon Button Mat <i>Recommend stocking 2 each per 10 units purchased</i>	PL-0199-L00-00	Yes	
14	EN-0078-L00-00	Display PCB <i>Recommend stocking 2 each per 10 units purchased</i>	EN-0078-L00-00	Yes	
15	12-8305	Quartz Spiral UV Faucet <i>Recommend stocking 2 each per 10 units purchased</i>	FU-0007	Yes	
16	12-1500	Solenoid Valve DC24V 1000mm <i>Recommend stocking 2 each per 10 units purchased</i>	PU-4016	Yes	
17	12-8370	Hot Water Faucet <i>Recommend stocking 2 each per 10 units purchased</i>	PL-1351	Yes	
17.1	10-3048	Faucet Nipple – Blue with Screen <i>Recommend stocking 2 each per 10 units purchased</i>	PL-1013	Yes	
17.2	10-2600	Silicon Faucet O-ring <i>Recommend stocking 2 each per 10 units purchased</i>	CT-2007	Yes	
Remainder of Parts					
1.2	NA	Hot Tank Thermistor	HT-3002	No	
18	12-8003	Upper Shelf	ST-8136-R2	Yes	
19	12-8375	Transformer 1.6A / 120 V	EL-5147	Yes	
20	Purchase from John Guest	JG Equal Elbow Connector 1/4" John Guest P/N PI0308S	PU-4008	No	
21	12-5245	Main PCB Bracket	ST-8165-CN	Yes	
22	NA	Cold Tank Assembly - 4Liters	CT-2017-A	No	
23	PL-0202-L00-BL	Black Front Top Panel	PL-0202-L00-BL	Yes	
24	PL-0192-L00-SI	Silver Front Top Panel Trim	PL-0192-L00-SI	Yes	

25	EL-0148-L00-00	LED Light Pipe	EL-0148-L00-00	Yes	
26	Purchase from John Guest	JG 3/8" x 1/4" Reducing Elbow (PI211208S)	PU-4137	No	
27	12-8320	Firewall UV Lamp Rubber	CT-2088	Yes	
28	FW-0027	Firewall Mark IV Stainless Assy No internal components	FW-0027-I00-00	Yes	
29	AK-0064	UVC Sensor Assembly	AK-0064	Yes	
30	PL-0197-L00-BL	Black Bottom Front Insert Panel	PL-0197-L00-BL	Yes	
31	PL-0196-L00-SI	Silver Front Panel Trim	PL-0196-L00-SI	Yes	
32	Purchase from John Guest	JG Reducing Elbow Connector 5/16" * 1/4" (PI211008S)	PU-4007	No	
33	Purchase from John Guest	JG Equal Tee Connector 1/4" (PI0208S)	PU-4011	No	
34	CU-0001	Solenoid Cushion	CU-0001	Yes	
35	12-8005	Filter Bracket	ST-8138	Yes	
36	20-1010	2.8" Filter Clip	PU-4161	Yes	
37	10-3083	Unit Rubber Feet	ST-8016	Yes	
38	12-8004	Bottom Tray	ST-8137	Yes	











39	12-3155	Leak Tray	PL-1294-A	Yes	
40	12-3180	Leak Containment Tray Clip (sensor 0.5mm)	ST-8207-CN	Yes	









Verify compressor in machine before ordering parts as the Compressor P/N CO-0020-L00-00 and 10-2200 (CO-0001A) and related parts are not interchangeable.

CO-0020-L00-00 Compressor (WL2FL-FX)

41A.1	CO-0020-L00-00	LG Compressor 120V R134A CSB035LJCM	CO-0020-L00-00	Yes	
41A.2	CO-0019-L00-00	Compressor Capacitor	CO-0019-L00-00	Yes	
41A.3	ST-0216-L00-00	Capacitor Bracket	ST-0216-L00-00	Yes	
41A.4	CO-0017-L00-00	PTC Relay	CO-0017-L00-00	Yes	
41A.5	CO-0018-L00-00	Overload Protector	CO-0018-L00-00	Yes	

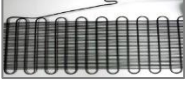
CO-0043-I00-00 Compressor (WL2FL-FZ)

41B.1	CO-0043-I00-00	Samsung Compressor (R134a 1/8HP) 120V/60Hz		Yes	
41B.2		Compressor Starter Relay		Yes	
41B.3		Overload Protector		Yes	
41.1	12-1001	Filter Dryer	CO-9008	Yes	
42	10-3067	Bulkhead Union 1/4" x 1/4" John Guest P/N PI1208S	PU-4028	Yes	
43	10-4004	Black Plastic Handle	PL-1120	Yes	
44	ST-0202-L00-BL	Tower Side Panel - Black	ST-0202-L00-BL	Yes	
45	19-1015	Gasket for Power Socket	ST-8052	Yes	
46	19-1090	Power Line Noise Filter, ElectroMagnetic Interference filter (EMI)	EL-5029	Yes	
47	10-3014	Fuse Holder and Fuse 120V / 15A with One Wire	EL-5053	Yes	

47.1	10-3013	Fuse 120V / 15A	EL-5010	Yes	
48	12-5600	Red Heater and Compressor Switch	EL-5019-A	Yes	
49	NA	Tower Back Panel - Black	ST-0203-L00-BL	No	
50	19-1069	Cold Tank Thermostat 3°C (37.4°F)	CT-2070-A	Yes	
50.1	LP-0326	Cold Thermostat Cover Label	LP-0326-L00-00	Yes	
51	12-8102	Wire Condenser	CO-9027	No	
52	Purchase from John Guest	JG LLD PE Tube - Blue O.D.1/4" John Guest P/N PE-08-BI-1000F-B	PU-4031	No	
53	10-7040	Silicon Tube 5/16" for hot water	PL-4064-L00-00	Yes	
Not Shown	10-3007	Power Cord 120V – 18240mm	EL-5001-B	Yes	

WL2FL COUNTER TOP WATER FLOW DIAGRAM

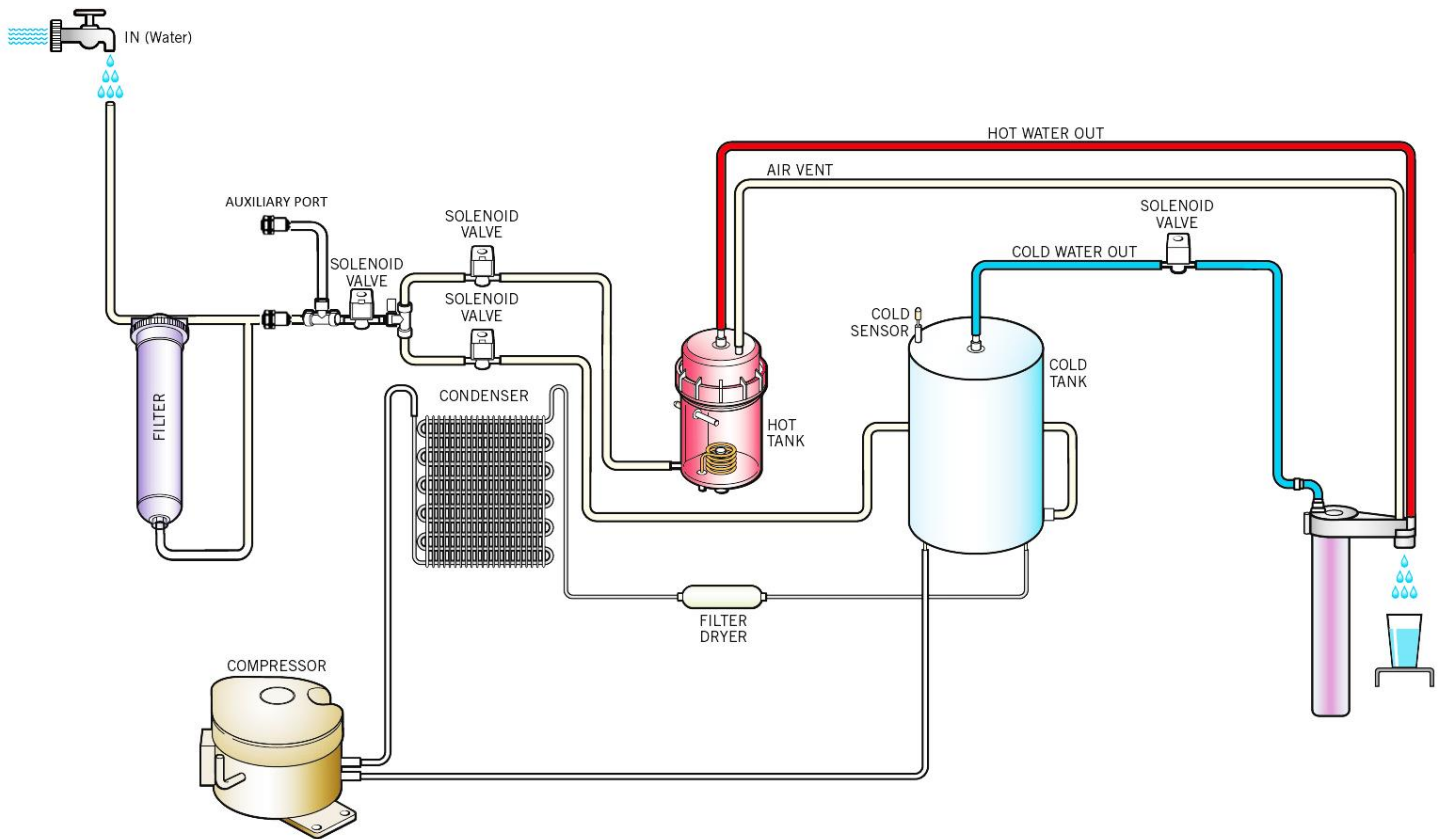

WL2FL TOWER WATER FLOW DIAGRAM

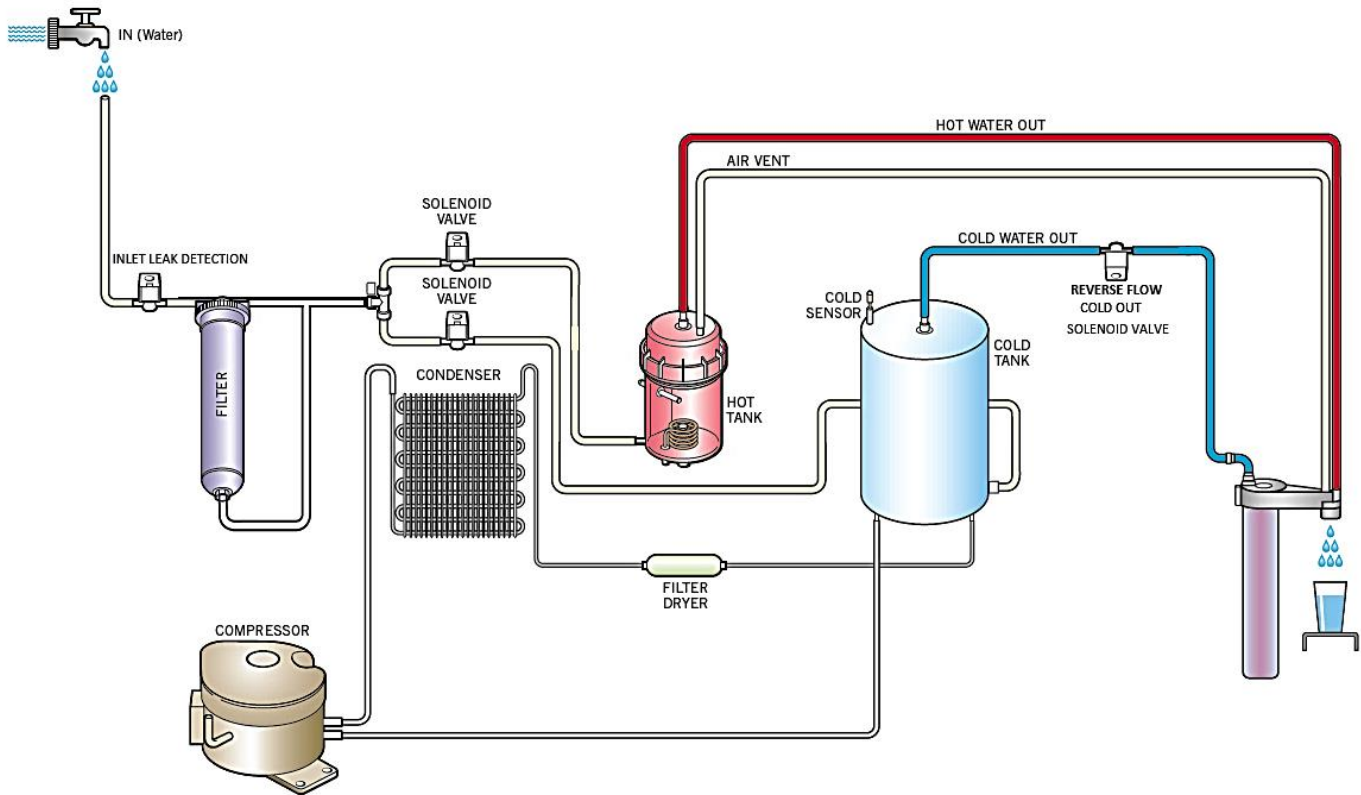

WL2FL ELECTRICAL DIAGRAM

⚠ DANGER! HIGH VOLTAGE ELECTRICAL HAZARD. PCB (Printed Circuit Board) contains High Voltage. Only trained and qualified technicians should attempt live testing.

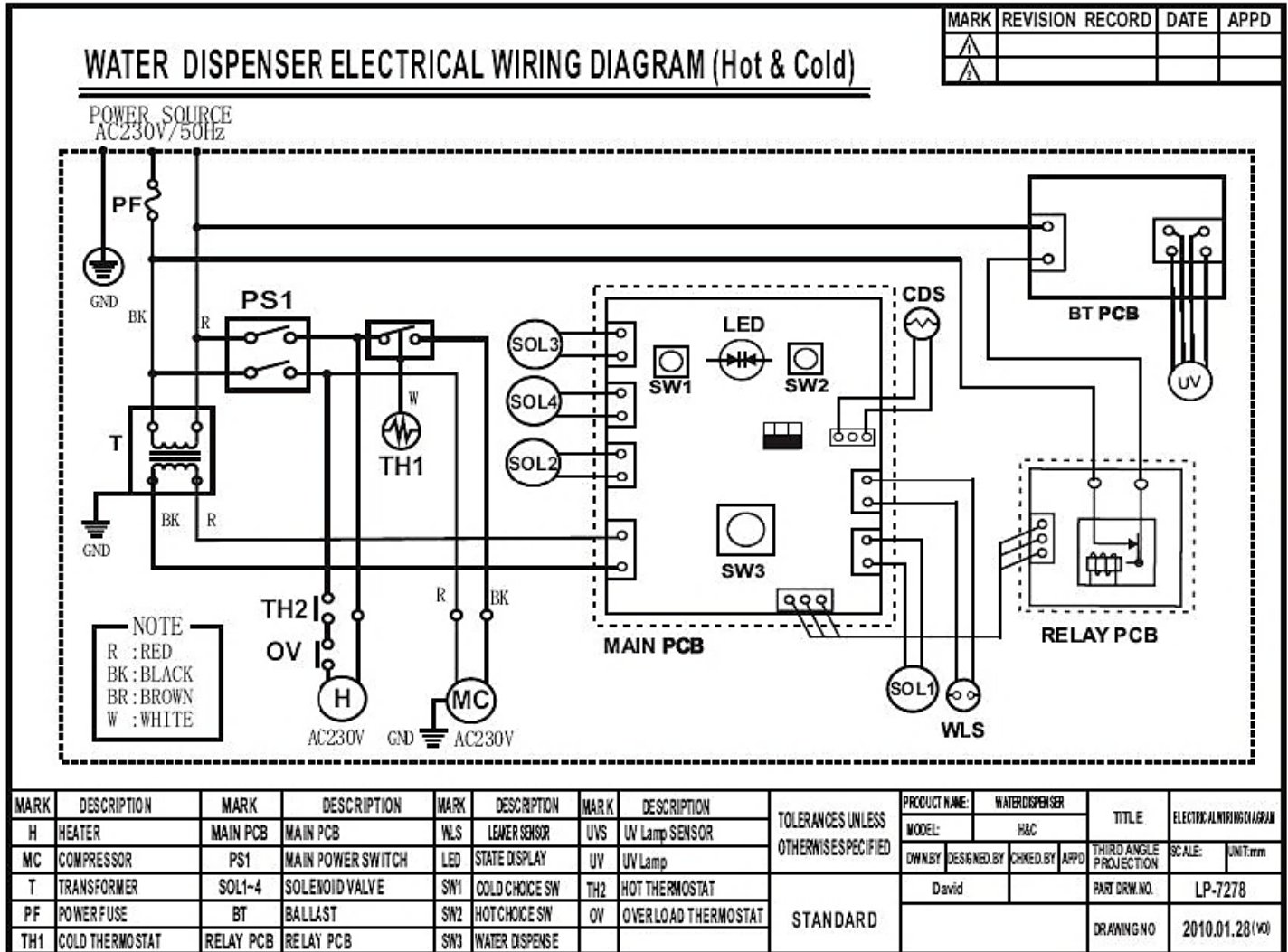

PRE-INSTALLATION PROCEDURES



DANGER! ELECTRICAL SHOCK HAZARD.

Only qualified personnel who have read and understand this entire manual should attempt to install, or service this unit, failure to do so could result in death or serious injury. DO NOT plug into an electrical supply until specifically instructed.



WARNING! ALWAYS SANITIZE BEFORE USE.

Sanitize before use to eliminate any potential microbiological contaminants.

Red Compressor/Heater Switch must be in the O=OFF position while the Hot Tank is empty. Damage could occur within one minute and the two Hot Tank Overload Devices (High Safety Limit) require manual reset if heater is turned on with an empty Hot Tank.



CAUTION! DRIP TRAY DRAIN.

If you intend to provide a drip tray drain for your customer, be aware that you will be called multiple times per month to service and unclog the tubing leading away from the drip tray to drain. Users will clog the drain with paper clips, erasers, napkins, tea bags, gum, and various other intended items. Waterlogic recommends you establish a minimum of weekly visits to the machine for cleaning of the drip tray drain.

Materials Needed:

- Personal Protective Equipment. Rubber or Nitrile Safety Gloves and Protective Eyewear
- Phillips Screwdriver
- Temperature Gauge
- Water Pitcher or Container to collect water from the faucet
- 16 Liter (5 gallon) container or drain basin
- Sanitizer - Household Bleach (5.25% Sodium Hypochlorite) or Citric Acid Based Cleaner
- ¼" Plastic Tubing, at least 4 feet in length, and assorted ¼" quick connect fittings
- TDS Meter and Test Strips for measuring chlorine – Optional
- Sanitizing Cartridge

1. Unpack the **Waterlogic WL2FL Water Treatment Systems** and check exterior for damage.

Sanitizing

Sanitize using a Household Bleach (5.25% Sodium Hypochlorite solution) or other approved cleaner throughout the cold and sparkling water circuits. Follow all instructions on the sanitizer and flush with fresh water through the faucet until odor and taste is acceptable.

⚠ WARNING! USE PROPER PERSONAL PROTECTIVE EQUIPMENT

Always ensure proper ventilation and use proper personal protective equipment such as gloves and eye protection when using chemicals. Refer to Material Safety Data Sheet for specific requirements of each chemical product. Take all necessary precautions to prevent sanitizer from contacting eyes, clothing, and any other surfaces in could damage (carpets).

- Put 1 teaspoon of sanitizer per directions or use Bleach Solution (1 teaspoon = 1/6 oz. = 5 ml = ½ cap full) of household bleach (Sodium Hypochlorite 5 - 10% Concentration) in the Sanitizing Cartridge. Always ensure sanitizer is compatible with stainless steel and acetyl plastic.
- Connect sanitizing cartridge to inlet water supply and connect to inlet bulkhead fitting on back of unit. Turn on water supply.
- Connect power to **WL2FL Water Treatment System**. DO NOT TURN ON RED COMPRESSOR & HEATER SWITCH AT THIS TIME. O=OFF



Fill the Cold Circuit with Sanitizer

- Depress the Main Dispensing Button on the Front Control Panel until cold water/sanitizing solution comes out the faucet. **NOTE:** Container and drain basin will be required to catch the water from the faucet.

⚠ WARNING! *Use Personal Protective Equipment. Gloves and Eye Protection Required. The first 7.5 or 11.5 Liters (2 or 3 Gallons) of water will contain concentrated sanitizer. Use extreme care!*

- Turn off water supply and remove Sanitizing Cartridge from inlet water supply. Reconnect water supply to Inlet Bulkhead Fitting.

Flush Filters

⚠ CAUTION! FILTER FLUSH REQUIRED.

WL2FL Water Treatment Systems are not supplied with filters. Filters should be configured to optimize your system. Filters need to be configured and specified to do the job given the local water conditions, usage, maintenance schedule, and placement restrictions.

In order for our filters to perform as represented and to provide the best quality water possible, it is essential that filters be replaced periodically. The frequency of filter changes depends upon your water quality and your water usage. For example, if there is a lot of sediment and/or particles in your water, then you will have to change your filters more frequently than a location with little to no sediment. Be sure to replace your filters whenever you notice a decline in the performance, whether it is a drop in flow rate and/or pressure or an unusual taste in the water.

7. Flush thoroughly per filter manufacturers' recommendation with fresh water to drain.
8. Once flushed, install the filters. Following the flow direction on the filter.

NOTE: Filters should not be flushed prior to 24 hours before installation to limit Microbial Growth.

9. Connect **WL2FL Water Treatment System** to power.

⚠ CAUTION! NEVER TURN ON HEATER BEFORE FILLING HOT TANK.

*Red Heater & Compressor Switch must be in the O=OFF position while the hot tank is empty. Damage could occur within one minute and the overload (high limit) will require manual reset if heater is turned on with an empty hot tank.
O=OFF*



Flushing the Sanitizer from the Machine

10. Place a pitcher, catch basin, or other container under the faucet of the **WL2FL Water Treatment System**.
11. Flush the Cold Tank. Run several liters (gallons) of water through the faucet by dispensing cold water to dilute and remove the sanitizer from the cold circuit. You can use chlorine test strips to evaluate the water.
12. Once the sanitizer odor/taste has been flushed out of the cold side of the machine the sanitization process for the Cold Circuit is now complete.

Fill the Hot Tank

13. Press the Hot Water Select Button, followed by the main dispensing button to fill the hot tank. Water will dispense from the faucet once the hot tank is full. Flush until water is clear.

⚠ WARNING! HOT CIRCUIT IS NOT SANITIZED.

Water in the hot circuit is not sanitary until the temperature exceeds 77°C (171°F) for at least 5 minutes.

UV System Functional Test

⚠ WARNING! ULTRAVIOLET RADIATION. *Protect your skin and eyes against ultraviolet rays. Never look directly at an operating UV light. Disconnect wiring before removing.*

14. Remove UV Firewall™ Lamp from Firewall™ housing. Remove Top Cover from Firewall™ housing. Carefully remove Quartz Spiral from Firewall™ Housing and inspect for cracks or other damage. Reinsert Quartz Spiral, replace Top Cover of Housing. Inspect UV lamp and reinsert into Housing.
15. Press dispensing button and check for blue glow from top of Firewall™ Housing and at Faucet dispensing area to ensure UV lamp is operational.

Note: *UV Lamp Sensor is temperature sensitive. During extended periods of use, especially when filling or draining the unit, when water is not being dispensed UV lamp sensor can overheat initiating a UV fault. If this occurs turn off unit for 5 minutes and allow sensor to cool before resuming operation*

16. Disconnect UV lamp to test UV lamp sensor operation. Unit should alarm and green indication LED on front of unit should flash.
17. Disconnect power to **WL2FL Water Treatment System**.
18. Reconnect UV lamp.
19. Connect power to **WL2FL Water Treatment System**.

Compressor Test

20. Red Heater & Compressor to be in the on position *I=ON*. Always ensure tanks are full of water before turning on the heater or the overload (high limit) will open and require manual reset. If the wire condenser at back of the unit is warm, the refrigeration system is working. *I=ON*



21. Once the **WL2FL Water Treatment System** reaches its target temperature, the compressor will shut off. Draw a glass of cold water and verify it has chilled to proper temperature <46F.

Heater Test

22. Always ensure tanks are full of water before turning on the Heater or the Overload (High Limit) will open and require manual reset. It will take the heater approximately 10 minutes to heat the water from ambient 24°C (75°F) to the factory set point of 87°C (187°F). Dispense a cup of hot water to ensure the temperature/odor/taste is acceptable.

⚠ WARNING! HOT WATER CAN BURN OR SCALD. *The WL2FL Water Treatment System produces Hot Water up to 87°C (187°F). Water above 52°C (125°F) can cause severe burns or scalding. Hot water should be dispensed carefully into insulated container to avoid injury.*

WL2FL COUNTER TOP DRAINING INSTRUCTIONS

Draining Notes

Drain the **WL2FL Water Treatment System** for transportation.

⚠ WARNING! *STORE UNIT EMPTY. ALWAYS SANITIZE BEFORE USE OR AFTER SYSTEM FAILURE.*

The unit must be completely drained and sealed before storing to avoid stagnation and reduce microbial growth).

Prior to draining the Hot Tank, turn off the Red Heater and Compressor Power Switch (*O=OFF*), and dispense 2 liters (½ gallon) of hot water from the machine. As hot water is dispensed from the faucet of the **WL2FL Water Treatment System**, colder water will be introduced into the Hot Tank. Since the Red Heater and Compressor Power Switch is turned off, the Heater will not energize and heat the incoming tap water. Following this precaution prevents exposing personnel and equipment (drains, catch basin, etc.) to scalding hot water.



Disable Cold and Hot Tanks

1. Turn off the Red Heater and Compressor Power Switch (*O=OFF*) to disable the Heater and Compressor.
2. Dispense 2 liters (½ gallon) of water through the Hot Tank to cool the water temperature in the Hot Tank and avoid burns.



⚠ WARNING! *HOT WATER.* *The WL2FL Water Treatment System produces Hot Water up to 87°C (187°F). Water above 52°C (125°F) can cause severe burns or scalding. Hot water should be dispensed carefully into insulated container to avoid injury.*

Turn off Water Supply and Bleed Water Pressure

3. Isolate the **WL2FL Water Treatment System** from feed water by turning off the supply.
4. Dispense cold still water to relieve any pressure built up in the system.
5. Remove the water supply line from the inlet line bulkhead fitting at back of the **WL2FL Water Treatment System**.

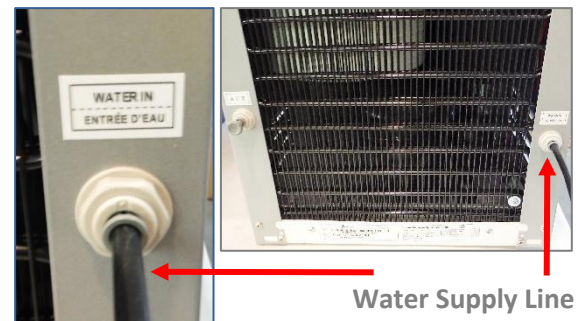

6. Depress Cold Water Dispense Button until all Cold Water has drained from the **WL2FL Water Treatment System**.
7. Depress Hot Water Dispense Button until all Hot Water has drained from the **WL2FL Water Treatment Machine**.

WL2FL TOWER DRAINING INSTRUCTIONS

Draining Notes

Drain the **WL2FL Water Treatment System** for transportation.

⚠ WARNING! *STORE UNIT EMPTY. ALWAYS SANITIZE BEFORE USE, OR AFTER SYSTEM FAILURE.*

The unit must be completely drained and sealed before storing to avoid stagnation and reduce microbial growth).

Prior to draining the Hot Tank, turn off the Red Heater and Compressor Power Switch (*O=OFF*), and dispense 2 Liters (½ Gallons) of hot water from the machine. As hot water is dispensed from the faucet of the **WL2FL Water Treatment System**, colder water will be introduced into the hot tank. Since the Red Heater and Compressor Power Switch is turned off, the heater will not energize and heat the incoming tap water. Following this precaution prevents exposing personnel and equipment (drains, catch basin, etc.) to scalding hot water.



Disable Cold and Hot Tanks

8. Turn off the Red Heater and Compressor Power Switch (*O=OFF*) to disable the heater and compressor.
9. Dispense 2 liters (1 gallon) of water through the hot tank to cool the water temperature in the hot tank and avoid burns.



⚠ WARNING! *HOT WATER. The WL2FL Water Treatment System produces Hot Water up to 84°C (187°F). Water above 52°C (125°F) can cause severe burns or scalding. Hot water should be dispensed carefully into insulated container to avoid injury.*

Turn off Water Supply and Bleed Water Pressure

10. Isolate the **WL2FL Water Treatment System** from incoming feed water by turning off the supply.

11. Dispense cold still water to relieve any pressure built up in the system.
12. Insert approx. 3 inches of blue tubing into the Line Bulkhead fitting at back of the **WL2FL Water Treatment System** to allow water to drain.
13. Depress Cold Water Dispense Button until all Cold Water has drained from the **WL2FL Water Treatment System**.
14. Depress Hot Water Dispense Button until all Hot Water has drained from the **WL2FL Water Treatment System**
15. Alternate draining method; disconnect inlet tank inlet lines at solenoid valves to drain unit without power.

Bulkhead Fitting



INSTALLATION PROCEDURES

Safety and Installation Guidelines

Ensure all Local, State, and Federal Laws and Codes including health and safety guidelines are met when installing **Waterlogic** Equipment. Only qualified service technicians should attempt installation and service of **Waterlogic** Equipment.

- ⚠ WARNING! ELECTRICAL SHOCK HAZARD.** Always unplug (isolate from power supply) to prevent electrical shock except where electrical tests are specified.
- ⚠ WARNING! IMPROPER SUPPLY OR CONNECTION CAN RESULT IN RISK OF SHOCK.** Connect to a 15 amp 120V 60Hz properly grounded outlet (GFI is recommended). Ensure polarity is correct and always use a 3-prong outlet. Consult a qualified electrician if you have any questions.
- ⚠ WARNING! USE ONLY Waterlogic SUPPLIED POWER CORD.** Locate system within 5 feet of power supply. Never use an extension cord or adapter. Do not use a damaged power cord or plug. Keep power cord out of heavy traffic areas and away from heat sources. Do not, under any circumstances, remove ground prong or alter the power cord. Never pull the power plug from the outlet with a wet hand or allow the plug to get wet. Failure to use the supplied power cord will void UL Certification and Warranty.
- ⚠ CAUTION! INDOOR USE ONLY.** Never expose to direct sunlight, heat sources, or ambient air temperature above 37°C (100°F) or below 2°C (35°F). Install indoors and keep unit away from excessive humidity. Never expose to freezing temperatures. Ensure there is adequate clearance around the unit to allow refrigeration system condenser to dissipate heat. Warmer environments require more clearance around the unit. Minimum clearance around all surfaces of the machine is 2-inches. Installs where the ambient temperature exceeds 27°C (80°F), require a minimum of 4-inches clearance for proper heat dissipation and efficient operation.
- ⚠ CAUTION! USE A WATER PRESSURE REGULATOR.** **Waterlogic** will not be responsible for injury or damage caused by excessive water pressure. Operating pressure must be 40 psi to 60 psi. Be aware any of potential pressure surges caused by building/municipal pumping stations.
- ⚠ CAUTION! USE UV STABILIZED SUPPLY LINES.** Feed the unit with a potable ambient or cold water supply only. Feed water over 37°C (100°F) can damage the treatment components. Water block devices and external leak detectors are strongly recommended. Locate the unit as close to the water supply and the electrical connections as possible.
- ⚠ WARNING! STORE AND TRANSPORT UNIT EMPTY. ALWAYS SANITIZE BEFORE USE, OR AFTER SYSTEM FAILURE**
The unit must be completely drained and sealed before storing to avoid stagnation and reduce microbiological contamination (potential bacterial growth). Sanitize before use, or after system failure to eliminate any potential microbiological contaminants

Pre-installation and sanitization procedures as prescribed in this manual must be performed before installing the **WL2FL Water Treatment Systems**.

Always install indoors and place the **Waterlogic WL2FL Water Treatment System** on a firm, flat and stable surface.

1. Attach the water supply line to the 1/4" feed water inlet bulkhead fitting on the back of the unit. **Waterlogic** requires the use of a water pressure regulator. Water feed pressure must be between 40-60 psi. Turn on the water supply and check for leaks.

2. Check to ensure that the Red Compressor & Heater switch is the *O=OFF* position.



NOTE: Switch has internal LED that illuminates when placed in *I=ON* position.

3. Connect the power cord to the back of the **Waterlogic WL2FL Water Treatment System** and to a 120 Volt supply.
4. Fill the Cold Tank. Hold a container under the dispensing faucet, press and hold the main dispensing button until a continuous flow of water is obtained. Once a continuous flow is obtained, release the dispensing button. Cold Tank is now full.
5. Fill the Hot Tank. Hold a container under the dispensing faucet. Press the Hot Select Button followed by the main dispensing button until a continuous flow of water is obtained. Once a continuous flow is obtained, release the main dispensing button. Hot tank is now full.

⚠ CAUTION! NEVER TURN ON HEATER BEFORE FILLING HOT TANK.

*Red Compressor/Heater Switch must be in the *O=OFF* position while the hot tank is empty. Damage could occur within one minute and the overload (high limit) will require manual reset if heater is turned on with an empty hot tank.*



6. Verify that the UV lamp operates as expected.

⚠ WARNING! ULTRAVIOLET RADIATION. *Protect your skin and eyes against ultraviolet rays. Never look directly at an operating UV light. Always disconnect before removal.*

7. Move the **Waterlogic WL2FL Water Treatment System** into its final operating position. Be sure that a minimum of 2" clearance is maintained around both the sides and the back of the unit. This is important to allow proper airflow and heat exchange of refrigeration system.
8. Level unit using the adjustable feet to level if necessary. Never install on incline.
9. Turn the Red Compressor & Heater Power Switch to *I=ON* position.
10. When the unit has reached its Hot Temp Set Point, the heater will cycle off.
When the unit has reached its Cold Temp Set Point Temperature, the compressor will cycle off.
11. Once the unit is at the target temperature(s), sample the water to ensure water meets expectations and additional rinsing or adjustment is not required.
12. Check the **WL2FL Water Treatment System** for any leaks. External Leak Protection is always recommended.



FAULT CODE TROUBLESHOOTING INDEX

1. Red Light Flashing and Beeping
2. Green Light Flashing and Beeping
3. Orange LED Light (Indicates Heater is ON - this not an error or fault)
4. No LED Light

1. FAULT CODE: Red Light Flashing and Beeping indicate that the Leak Detector has sensed water in the Leak Tray and will shut down inlet solenoid.

Possible Reason	Solution
<p>Water is present in the Bottom Tray, causing the leak detection to trigger.</p> <p><i>*Leak Detection is on the Counter Top Model only.</i></p>	<p>Remove the Top Cover and Front Panel. Tip the unit slightly to drain, dry Bottom Tray completely.</p>
<p>Leak in WL2FL Water Treatment System Counter Top</p>	<p>Water is in the bottom of the WL2FL Water Treatment System. Clear Leak Detection Tray to ensure inside of unit is dry.</p> <p>Check for source of leak and fix as necessary.</p>



2. FAULT CODE: Green Light Flashing and Beeping - Indicates the Firewall™ UV system is not detecting adequate dose of UV to ensure safe water.



****The Cold Solenoid will shut down and no cold water will dispense. Hot water will still dispense.***

Possible Reason	Solution
<p>Firewall™ UV System does not have adequate dose of UV.</p>	<p>Check UV System</p> <ol style="list-style-type: none"> 1. If Ballast Indication Light is Green – the system should be operational. Ensure UV lamp is on. Replace Lamp. If lamp is replaced and problem persists, replace UV Sensor. 2. If Ballast Indication Light is Red, change UV Lamp. 3. If Ballast Indication Light is not lit – check power to Ballast. If power is going to Ballast – replace Ballast.

Remove Cover to locate Ballast

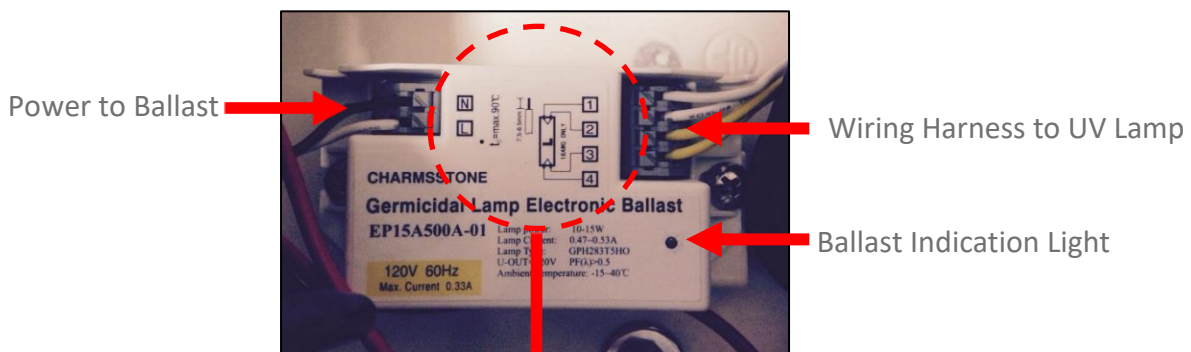

N = Black Wire
L = White Wire (Live)

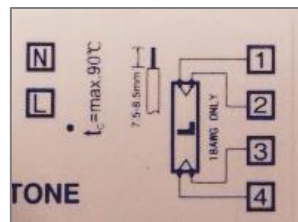

1 = White Wire
2 = White Wire
3 = Yellow Wire
4 = Yellow Wire

3. FAULT CODE: Orange LED Light

Possible Reason	Solution
Heater is ON	Indicator that heater is ON.



4. FAULT CODE: No LED Light

Possible Reason	Solution
Power Problem	Check for power disruption.
LED Light is out	Check that the PCB LED is operational – replace PCB as necessary.



POWER TROUBLESHOOTING INDEX

1. Red Heater & Compressor Power Switch won't light and the Red LED on the Front won't light
2. Red Heater & Compressor Power Switch is lit but the red LED on the Front is not lit
3. Compressor Runs but does Not Chill
4. Compressor is Not Running

1. Red Heater and Compressor Power Switch won't light and the Red LED on the Front won't light

Possible Reason	Solution
Circuit Breaker	Check the Circuit Breaker
Fuse is Blown	Replace Fuse
Defective / Loose Power Cord	Check that Power Cord is properly plugged in. If it is properly plugged in, use a different power cord to verify.
Failed Socket - Power Line Noise Filter, ElectroMagnetic Interference filter (EMI)	Replace Socket - Power Line Noise Filter, ElectroMagnetic Interference filter (EMI)
Defective Red Heater & Compressor Switch	Replace Red Heater & Compressor Switch



2. Red Heater & Compressor Power Switch is lit but the Red LED on the Front is not lit

Possible Reason	Solution
Bad Transformer	Replace Transformer
Black Power Connector to the PCB is not properly connected	Properly connect.
Bad Front PCB	Replace Front PCB
Defective Red Heater & Compressor Switch	Replace Red Heater & Compressor Switch

3. Compressor Runs But Does Not Chill

Possible Reason	Solution
Condenser is dirty	Clean the condensing coil of any obstructions or dust.
Reduction of airflow into unit.	Make sure unit is not under minimum ventilation requirements (2 to 4 inches).
Compressor is running very hot.	Low or lost refrigerant. Counter Top should be 40 grams (1.41 ounces) Tower should be 65 grams (2.29 ounces) Refrigerant recharge as necessary.

4. Compressor is Not Running

Possible Reason	Solution
Red Heater & Compressor Switch button on unit is in the off position	Turn Red Heater & Compressor Switch on. <i>I = ON</i> 
Compressor Starting Circuit	Turn Red Heater & Compressor Switch off. <i>O = OFF</i> . Remove the compressor cap on side of the compressor; Disconnect the black and red terminal connectors; Inspect the starter and overload relay for any defects. Replace components(s) as needed. Turn Red Heater & Compressor Switch on <i>I = ON</i> and retest compressor operation.  

DISPENSE TROUBLESHOOTING INDEX

1. Irregular / Intermittent Dispensing from One Side
 2. Hot Water Intermittently Forced Out Through the Faucet, or a Dual Stream Out of the Faucet
 3. Dispensing won't stop when not holding the Dispensing Button
 4. Steady Drip out of Faucet
 5. Hot Water or Steam coming out of both the Faucet and the Vent Hole
 6. Hot Water coming out of Faucet Vent Hole
 7. Low Flow of Water
 8. Restricted Flow of Hot Water
 9. Hot Water Drip out of Faucet
 10. Dispenses Hot and Cold Water at the same time
 11. No cold water available
 12. Water does not dispense from unit
 13. No Water is Dispensing from One Side – Cold or Hot
 14. Cold Water dispenses from Faucet and Vent Outlet Simultaneously
 15. Small amount of water periodically dispenses from faucet automatically
 16. Dispense Buttons Stick
 17. Water Stream is at an Angle
 18. Run-On - Water continues to dispense out of faucet after releasing the dispense button
- *Also includes related instruction for Hot Tank Descaling*

1. Irregular / Intermittent Dispensing from One Side

Possible Reason	Solution
Too much water pressure. Recommend 40 to 60 psi for the WL2FL Water Treatment System to operate properly.	<p>The correct input water pressure is critical to the performance of the unit to allow solenoids to open.</p> <p>Check water pressure at the inlet bulkhead with a water pressure gauge.</p> <p>Additional method of verification is to turn off water to unit and press the dispense button. Does the solenoid open without water pressure to the unit? Listen for solenoid to activate, not button “click”.</p> <p>Adjust water pressure to 40-60 psi.</p>
Loose or bad connection on the Front Dispensing PCB or Solenoid Connector	Check that they are connected properly and tightened.
Solenoid	<p>If both the Water Pressure and PCB have been ruled out, then it is the Solenoid.</p> <p>Replace Solenoid.</p>
Dispensing button is broken on PCB	Check PCB for loose or damaged button. Replace PCB as necessary.

2. Hot Water Intermittently Forced Out Through the Faucet, or a Dual Stream Out of the Faucet

Possible Reason	Solution
Mineral deposits on the expansion slot inside the hot tank vent chamber which blocks the normal path of water to expand.	<p>Descale Hot Tank</p> <p><u>See Hot Tank Descaling Instructions that are included further below in this Troubleshooting Section.</u></p>

3. Dispensing Won't Stop When Not Holding the Dispensing Button

Possible Reason	Solution
Too much water pressure. Recommend 40 to 60 psi for the WL2FL Water Treatment System to operate properly.	<p>The correct input water pressure is critical to the performance of the unit to allow solenoids to open.</p> <p>Check water pressure at the inlet bulkhead with a water pressure gauge.</p> <p>Additional method of verification is to turn off water to unit and press the dispense button. Does the solenoid open without water pressure to the unit? Listen for solenoid to activate, not button "click".</p> <p>Adjust water pressure to 40-60 psi.</p>
Bad Display PCB	Replace Main PCB
Debris in the Solenoid	Inspect Solenoid for debris and clean out as needed.
Dispensing Button Stuck	Dirt or Foreign material is filling the gap around the push-buttons. Inspect the push buttons and clean surrounding area. Inspect faucet assembly inside the unit and clean as necessary.

4. Steady Drip Out of Faucet

Possible Reason	Solution
Debris in Solenoid	Inspect Solenoid for debris and clean out as needed.

5. Hot Water or Steam Coming out of both the Faucet and Vent Hole

Possible Reason	Solution
Improper tubing attachment from the Hot Tank to Faucet or vice versa.	Check that the tubing is connected from Hot Tank Outlets to correct Faucet attachments. Connect tubing to outlets as needed.

6. Hot Water Coming out of Faucet Vent Hole

Possible Reason	Solution
<p>Too much water pressure. Recommend 40 to 60 psi for the WL2FL Water Treatment System to operate properly.</p>	<p>The correct input water pressure is critical to the performance of the unit to allow solenoids to open.</p> <p>Check water pressure at the inlet bulkhead with a water pressure gauge.</p> <p>Additional method of verification is to turn off water to unit and press the dispense button. Does the solenoid open without water pressure to the unit? Listen for solenoid to activate, not button “click”.</p> <p>Adjust water pressure to 40-60 psi.</p>
<p>Improper tubing attachment from the tank to faucet or vice versa.</p>	<p>Verify tubing is connected properly from tank outlets to correct faucet attachments.</p>
<p>Hot Tank outlet hole is scaled over.</p>	<p>Inspect and Descale Tank as needed.</p> <p><u>See Hot Tank Descaling Instructions that are included further below in this Troubleshooting Section.</u></p>
<p>Expansion chamber is not sealed properly.</p>	<p>Replace the Hot Tank.</p>

7. Low Flow of Water – Rated Service Flow is 1.89 Liters (0.5 gallons) per Minute

Possible Reason	Solution
Determine Flow of Water	Rated Flow Rate is 1.89 Liters (0.5 gallons) per minute. Check flow rate by dispensing into a container to measure for one minute and measure the amount of water that was dispensed.
Feed Lines too small	Feed lines can restrict flow if run long distances from the supply. It may be necessary to increase the supply line (e.g., use 3/8" feed line vs. 1/4").
Elbows and turns in the feed line	Minimize elbows and turns in the feed line.
Filters	Filters with high pressure drop due to fouling or just by design. Change filters more frequently or go to higher micron size filter for local water conditions.
Restrictions	Follow flow path to ensure there are no undiscovered restrictions due to debris or malfunctioning valves, including the supply valve at the source.
Booster Pump	Add a booster pump to the supply line if the feed is slower than needed.

8. Restricted Flow of Hot Water

Possible Reason	Solution
Partially closed water supply valve to the unit.	Open water supply valve.
Hot Tank outlet hole is scaled over.	Descale Tank. <u>See Hot Tank Descaling Instructions that are included further below in this Troubleshooting Section.</u>
Tubing is creased or has a “kink” in it.	Inspect and replace tubing as necessary.
Faucet nipple screen mesh has obstruction(s)	Unscrew faucet nipple from faucet and remove any obstruction(s) from screen mesh.
Exhausted Filter	Replace the Filter
Solenoid connection to the Display PCB	Turn power off; unplug the WL2FL Water Treatment System and visually inspect solenoid connections into the Display PCB. Verify the soldering points on connections are secure into the board. Remove the PCB to inspect the front of the board.
Solenoid Valve is Malfunctioning	Inspect valve components for proper function. Replace as necessary.

9. Hot Water Drip out of Faucet

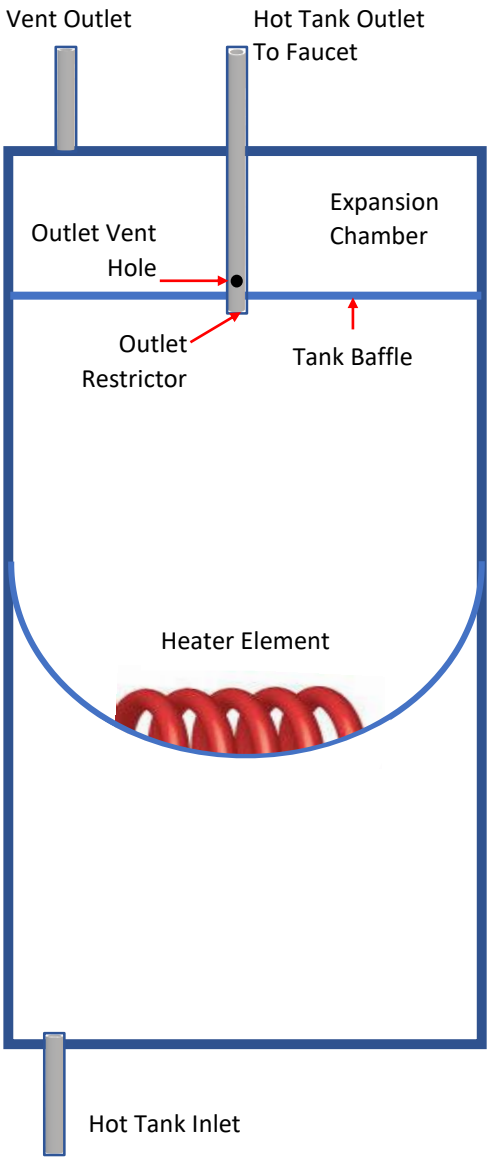
Possible Reason	Solution
<p>Small Outlet Vent Hole susceptible to scale build up.</p>	<p>Descalc Tank.</p> <p><u>See Hot Tank Descaling Instructions that are included further below in this Troubleshooting Section.</u></p>
	<p>All Waterlogic Hot Tanks have a built in Vent or Expansion Chamber in the top of the tank except for WL270 (GF) units.</p> <p>The Vent Chamber allows for expansion of the water when it is heated.</p> <p>The chambers are separated by a welded-in tank baffle.</p> <p>Water always flows into the bottom of the Hot Tank and out the top to the Faucet.</p> <p>The Hot Tank Outlet Tube has a Restrictor in its base. This ensures the reservoir is always full by allowing more water in than out.</p> <p>There is a small hole in the side of the Hot Tank Outlet Tube that allows air and water to pass into the Vent Chamber as it is heated.</p> <p>Water in the Vent Chamber is suctioned back through the Outlet Tube vent hole when water is dispensed.</p> <p>Expansion of water as it is heated in the Reservoir will push the water out the faucet when the outlet tube vent hole becomes plugged with debris or scale.</p> <p>The small Outlet Vent Hole is susceptible to scale build up and is a key indicator that descaling is required.</p> <p>It is critical to descale the Hot Tank through the vent line and outlet line on a regular basis to prevent this problem.</p> <p>Descaling through the inlet and/or outlet lines only will not clean the vent chamber and outlet vent hole properly.</p>

10. Dispenses Hot and Cold Water at the same time

Possible Reason	Solution
<p>Too much water pressure. Recommend 40 to 60 psi for the WL2FL Water Treatment System to operate properly.</p>	<p>The correct input water pressure is critical to the performance of the unit to allow solenoids to open.</p> <p>Check water pressure at the inlet bulkhead with a water pressure gauge.</p> <p>Additional method of verification is to turn off water to unit and press the dispense button. Does the solenoid open without water pressure to the unit? Listen for solenoid to activate, not button “click”.</p> <p>Adjust water pressure to 40-60 psi.</p>
<p>Hot or Cold solenoid is stuck open.</p>	<p>Remove Top Cover.</p> <p>Check Hot Solenoid: Dispense cold water and visually inspect tubing for water flow from both tanks.</p> <p>Check Cold Solenoid: Disconnect Elbow from outlet of Cold Solenoid. Select hot water and dispense (quickly releasing Dispensing Button to avoid much water coming out of Cold Solenoid.</p> <p>Replace Solenoid as necessary.</p>

11. No Cold Water Available

Possible Reason	Solution
Too much water pressure. Recommend 40 to 60 psi for the WL2FL Water Treatment System to operate properly.	<p>The correct input water pressure is critical to the performance of the unit to allow solenoids to open.</p> <p>Check water pressure at the inlet bulkhead with a water pressure gauge.</p> <p>Additional method of verification is to turn off water to unit and press the dispense button. Does the solenoid open without water pressure to the unit? Listen for solenoid to activate, not button “click”.</p> <p>Adjust water pressure to 40-60 psi.</p>
Closed Water Supply Valve	Open the Water Supply Valve
Cold Water Solenoid Valve malfunction	Inspect the valve components for proper functionality.
Red Heater & Compressor Switch on unit is off.	<p>If water is dispensing at room temperature:</p> <p>Turn Red Heater & Compressor Switch on. I =ON</p> 
Loose connection(s) on the Display PCB	<p>Turn power off; unplug the WL2FL Water Treatment System and visually inspect solenoid connections into the Display PCB. Verify the soldering points on connections are secure into the board.</p> <p>Remove the PCB to inspect the front of the board.</p>
Exhausted Filter	Replace filters as needed.

12. Water does not dispense from Unit

Possible Reason	Solution
<p>Too much water pressure. Recommend 40 to 60 psi for the WL2FL Water Treatment System to operate properly.</p>	<p>The correct input water pressure is critical to the performance of the unit to allow solenoids to open.</p> <p>Check water pressure at the inlet bulkhead with a water pressure gauge.</p> <p>Additional method of verification is to turn off water to unit and press the dispense button. Does the solenoid open without water pressure to the unit? Listen for solenoid to activate, not button “click”.</p> <p>Adjust water pressure to 40-60 psi.</p>
Closed water supply valve	Open the water supply valve.
The unit is not properly plugged into electrical outlet	Check electrical outlet connection, or for blown circuit breaker.
Red Heater & Compressor Switch button on unit is in the off position	<p>Turn Red Heater & Compressor Switch on. <i>I = ON</i></p> 
15 Amp Fuse Blown	Replace the 15 Amp Fuse as needed.
Water is present in the Bottom Tray, causing the Leak Detection to trigger	Remove the Top Cover and Front Panel. Tip the unit slightly to drain, dry Bottom Tray completely.
Hot and Cold Solenoid connections into the Display PCB are loose.	<p>Turn power off; unplug the WL2FL Water Treatment System and visually inspect Solenoid connections into the Display PCB. Verify the soldering points on connections are secure into the board.</p> <p>Remove the PCB to inspect the front of the board.</p>
Exhausted Filter	Replace filters as needed.

13. No Water is Dispensing from One Side – Cold or Hot

Possible Reason	Solution
<p>Too much water pressure.</p> <p>Recommend 40 to 60 psi for the WL2FL Water Treatment System to operate properly.</p>	<p>Verify water pressure at the Inlet Bulkhead with a Pressure Regulator.</p> <p>Additional method of verification is to turn off water to unit and press the Dispense Button. Does the Solenoid open without water pressure to the unit? Listen for solenoid to activate, not the Dispense Button “click”.</p> <p>Adjust water pressure to 40-60 psi. <i>The correct input water pressure is critical to the performance of the unit to allow solenoids to open.</i></p>
PCB	<p>Switch the hot and cold wires on PCB (red and blue connections).</p> <p>If water now dispenses from the opposite side, this is an indication that there is a PCB problem.</p> <p>Replace PCB</p>
Solenoid	<p>If both the Water Pressure and PCB have been ruled out, then it is the Solenoid.</p> <p>Replace Solenoid.</p>
See “Green Flashing Light” Fault Code Section of this Manual	Indicates the Firewall™ UV system is not detecting adequate dose of UV to ensure safe water.

14. Cold Water Dispenses from Faucet and Vent Outlet Simultaneously

Possible Reason	Solution
Improper tubing attachment from the Cold Tank to Faucet or vice versa	Verify tubing is connected properly from Cold Tank Outlets to correct Faucet attachments.
Scale has formed inside Cold Tank outlet tube.	Remove Cold Water Outlet Tube from Cold Tank to Faucet. Pour some scale remover into Cold Tank.
Expansion chamber in Cold Tank is not sealed properly.	Replace Cold Tank.

15. Small Amount of Water Periodically Dispenses from Faucet Automatically

Possible Reason	Solution
<p>Too much water pressure. Recommend 40 to 60 psi for the WL2FL Water Treatment System to operate properly.</p>	<p>The correct input water pressure is critical to the performance of the unit to allow solenoids to open.</p> <p>Check water pressure at the inlet bulkhead with a water pressure gauge.</p> <p>Additional method of verification is to turn off water to unit and press the dispense button. Does the solenoid open without water pressure to the unit? Listen for solenoid to activate, not button “click”.</p> <p>Adjust water pressure to 40-60 psi.</p>
<p>Cold or Hot Water solenoid valve malfunction</p>	<p>Inspect valve components for proper function. Replace as necessary.</p>
<p>Obstruction in solenoid housing is preventing proper sealing of component.</p>	<p>Pre-determine whether water being dispensed is hot or cold.</p> <p>Isolate the water supply; push the DISPENSE button to release the line pressure, and remove the coil affixed to the solenoid stem.</p> <p>Remove the stem from the solenoid housing and allow water from the tank to flush out the contaminant(s).</p>

16. Dispense Buttons Stick

Possible Reason	Solution
<p>Dirt or Foreign material is filling the gap around the Dispense Buttons.</p>	<p>Inspect the Dispense Buttons and clean surrounding area. Inspect Faucet Assembly inside the WL2FL Water Treatment System and clean as necessary.</p>

17. Water Streams at an Angle

	Solution
	<p>Rotate the Bung (Blue Silicone) and the JG fittings a few degrees.</p>
<p>Water Feed Pressure</p>	<p>Verify the Incoming Feed with a Pressure Regulator. Should be 40-60 psi (275-414 kPa) – Use Pressure Regulator</p> <p><i>The correct input water pressure is critical to the performance of the unit to allow solenoids to open.</i></p>
<p>Outgoing Flow Rate</p>	<p>Verify the outgoing Flow Rate. Should be 1.89 Liters per minute (0.5 gallons per minute) - Firewall™ Purification.</p> <p>Dispense water for one minute – should measure 1.89 Liters (0.5 gallons) per minute</p> <p>Change Flow Restrictor if needed.</p>

18. Run On – Water continues to dispense out of faucet after releasing the dispense button

Reason

“Run On” or “Carry On” is present in all Waterlogic pressure fed units without outlet solenoids.

“Run On” is defined as the amount of water that continues to dispense out of the faucet after releasing the dispense button.

Run On exists because the tanks pressurize as water is being dispensed. Every Waterlogic tank has an outlet restrictor to ensure the tanks remain full of water and water is controlled as it is released to the faucet. The inlet solenoid controls flow into the tanks. The tanks will “depressurize” once the dispense button is released the inlet solenoid closes. A small amount of water will “Run On” through the faucet as the tank depressurizes to atmospheric conditions.

Typical “Run On” is 2-3 seconds.

“Run On” can be reduced by installing a pressure limiting device.

The amount of inlet or supply pressure directly impacts the amount of “Run On” as quantified below.

WLCP Lab Testing of Rn On 7-31-2013

Pressure	Pressure	Time	Flow Rate	Run On
Static PSI	Dynamic PSI	4 Liters	l/min	Seconds
68	40	61	2.9508197	3
50	30	72	2.5	2.5
32	20	92	1.956217	2

Pressure measured at inlet line to unit. Static with unit closed. Dynamic with unit dispensing cold water.

No filters were installed in unit.

HOT TANK DESCALING INSTRUCTIONS

The Hot Tank requires removal of mineral deposits (descaling) on a regular basis. Typically descaling should take place every 6 to 12 months to preserve the long-term health of your unit.

Use non-toxic cleaner such as ScaleKleen, DEZCAL, 20% Citric Acid Solution, or Undiluted Vinegar Solution to remove mineral deposits as directed by the manufacturer depending upon filtration and local water conditions.

Descaling is an important process that removes calcium deposits, or scale, that can build up inside a tank over time. Calcium and scale is non-toxic but left unattended will hinder your unit's performance.

⚠️ WARNING! ***PERSONAL PROTECTIVE EQUIPMENT REQUIRED.** Always ensure proper ventilation and use rubber or nitrile gloves and eye protection when using chemicals. Refer to Material Safety Data Sheet for specific requirements of each product.*

⚠️ CAUTION! ***STAINLESS STEEL TANK DESCALING.** The Hot Tank is made from stainless steel. Ensure descaling solution is compatible with stainless and always flush the unit completely. Dispose in an environmentally safe manner.*

Materials Needed:

- Personal Protective Equipment. Rubber or Nitrile Safety Gloves and Protective Eyewear
 - Phillips Screwdriver
 - Temperature Gauge
 - Water Pitcher or Container to collect water from the faucet
 - 19 Liter (5 Gallon) container or drain basin
 - Citric Acid Based Cleaner
 - ¼" Plastic Tubing, at least 4 feet in length, and assorted ¼" quick connect fittings
 - Sanitizing Cartridge
 - Food Coloring
9. Put descaler per directions and 3 drops of food coloring into the descaling cartridge.
 10. Connect descaling cartridge to the inlet water supply and connect to inlet bulkhead fitting on the back of the **WL2FL Water Treatment System**. Turn on Water Supply.
 11. Select Hot Water and depress the Main Dispensing Button on the Front Control Panel until descaling solution (colored water) comes out of the faucet. Container and drain basic will be required to catch water from the faucet.
 12. Turn off water supply and remove sanitizing cartridge from inlet water supply. Reconnect water supply to inlet fitting.

13. Allow descaling solution to remain in the Hot Tank for 15 minutes (length of time may vary depending on water conditions).
14. Place a pitcher, catch basin or other container under the faucet of the **WL2FL Water Treatment System**.
15. Flush the Hot Tank until water runs clear.
16. Once clear Water dispenses from the faucet the Hot Tank has been descaled. Always ensure the **WL2FL Water Treatment System** is performing to the customer's satisfaction.

⚠ WARNING! HOT WATER. *The WL2FL Water Treatment System produces Hot Water up to 87°C (187°F). Water above 52°C (125°F) can cause severe burns or scalding. Hot water should be dispensed carefully into insulated container to avoid injury.*

⚠ CAUTION! MUST REPLACE HOT TANK 3-5 YEARS DEPENDING ON USAGE. *The Hot Tank and its controls must be replaced a minimum of every three to five years to ensure efficient and dependable operation.*

⚠ WARNING! REINSTALL ALL PANELS AND COVERS. *Always reinstall all Panels, Protective covers, and fasteners after servicing equipment. Failure to do so could result in severe personal injury and will void the certifications and warranty of the equipment.*

COLD WATER TROUBLESHOOTING INDEX

1. Cold Water is not Cold 5°± -1.5°C (41°± 5°F)

1. Cold Water is not Cold 5°± -1.5°C (41°± 5°F)

Possible Reason	Solution
No power or refrigeration elements	<p>Check that the Red Heater & Compressor switch is on.</p> <p>Turn Red Heater & Compressor Switch on. <i>I = ON</i></p> 
<p>Tank has run out of cold water.</p> <p><i>Cold tank capacity is 4 liters (1 Gallon) for Tower and 2 liters (½ Gallon) for Counter Top.</i></p>	<p>Wait for Cold Tank to chill water to temperature prior to dispensing more cold water.</p> <p>Greater capacity Waterlogic Water Treatment Systems are available.</p>
Cold Water Thermostat	Check continuity of Thermostat with multimeter. Replace Thermostat as required.
Refrigerant has run out	Run Compressor for at least ten minutes. If Condenser is not warm, then refill the refrigerant.
Compressor problem	If Compressor is not running, repair or replacement is needed.

Note: The Waterlogic Firewall™ reduces 7-log of waterborne bacteria, 5-log of viruses, and 4-log of parasites potentially found in the drinking water. A small amount (about 2-ounces) of water remains in the Firewall™ device after dispensing. This water does not remain permanently chilled, and will eventually become room temperature after several hours. To ensure the next glass of water dispensed is adequately chilled, Waterlogic recommends dispensing one 5-ounce or more cup of water after long periods of inactivity. The first 2-ounces will be near room temperature, and the remaining 3+ ounces will be very cold. The mixture of these two temperatures will provide for an adequately refreshing, cold drink.

HOT WATER TROUBLESHOOTING INDEX

1. Hot Water is not Hot 86°± -1.5°C (187°± 5°F)

Also includes related instructions for:

- *Disabling Energy Star Sleep Mode*
- *Resetting the Hot Tank Overload or High Safety Limit*

1. Hot Water is not Hot 86°± -1.5°C (187°± 5°F)

The Hot Temperature set point is 85°C (185°F) and is controlled by a thermostat on the side of the Hot Tank.

There is a resettable overload or high limit safety above the thermostat on the side of the Hot Tank that will trip to prevent damage to the unit if the tank is dry heated (turned on without water in it).

The **WL2FL Water Treatment System** is programmable to make Cold / Ambient water – refer to Disabling Sleep Mode instructions included further below in this Troubleshooting Section.

The **WL2FL Water Treatment System** does NOT have Extra Hot capability and the maximum hot temperature is 87°C (189°F).

It typically takes 10 minutes for the 500W to heat the 1.6 Liter (0.4 Gallon) of room temperature (ambient) water to the 85°C (185°F) set point.

Possible Reason	Solution
No Power	Check that the Red Heater & Compressor switch is on. Turn Red Heater & Compressor Switch on. <i>I = ON</i> 
Is unit in Energy Star Sleep Mode?	If no water has been dispensed for 3 or more hours, unit goes into sleep mode. Dispense hot water, wait 5 minutes, check temperature. If unit still does not heat proceed to “No power to Heater elements” below. <u>If unit does heat but you would like to Disable Sleep Mode, refer to the instructions included further below in this Troubleshooting Section</u>
Hot Tank Overload Tripped <i>Overload is a safety feature to ensure the tank does not overheat.</i>	Overload will “click” when pushed. The overload is automatically reset when pressed. <u>See Resetting the Hot Tank Overload or High Limit Safety Instructions that are included further below in this Troubleshooting Section</u>

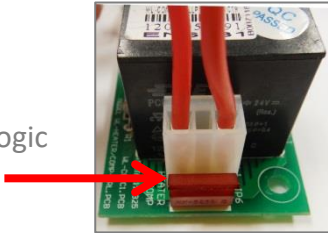
<p>Energy Saver PCB Relay Board Connector Bad</p>	<p>Inspect connector for discoloration. If there is no discoloration, contact Waterlogic Technical Department.</p> 
<p>Thermostat or overload “open” on Hot Tank</p>	<p>Turn Power off. Check OHM’s resistance across terminals on each Thermostat and Overload separately. Good components will indicate a closed circuit or zero OHM’s on the meter. Replace components as necessary.</p>
<p>Loose or improperly connected wire(s) to the Heating Element / Hot Tank.</p>	<p>Visually inspect wire leads going to the hot tank; confirm proper connections to the heating elements. Hot tank life is 3-5 years, depending on usage. <i>*Typically, dealers swap out the Hot Tank at site, take back to the shop to repair.</i></p>
<p>Heating Coil Not Heating</p>	<p>Turn Power off; Drain hot tank; Use multi-meter to check Heater Element for approximately 26 OHM’s resistance. Hot Tank must be empty if you are checking for continuity. Replace Hot Tank as necessary.</p>
<p>Improper Jumper Settings</p>	<p>The unit has been changed to a cold/ambient setting (JP9 has been moved from Pin 1 and Pin 2). Verify that Jumper Pins are located properly for Hot Water Option.</p>

DISABLING ENERGY SAVING SLEEP MODE

All **WL2FL Water Treatment Systems** come from the factory with Energy Saving Sleep Mode engaged to meet the Energy Star Certification requirements. Energy Saving Sleep Mode disables the heater circuit if the unit has not been used for a continuous 3 hour or longer period. Selecting any button "wakes up" the **WL2FL Water Treatment System** and turns the heater circuit back on. The hot tank will typically take less than 10 minutes to heat the water from ambient to the 85°C (185°F) set point.

Unplug Power Cord and remove Top Cover to access back side of the Display PCB.

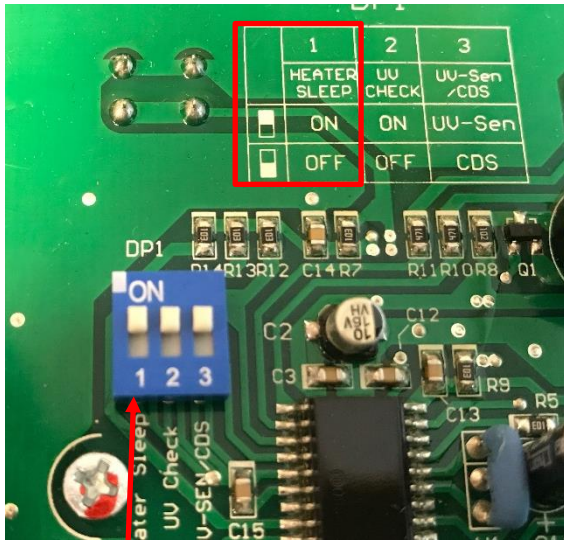

WL2FL Water Treatment Systems comes with the Energy Saving Sleep Mode "ON" - the Default Position.



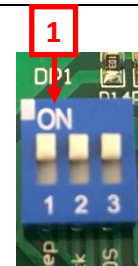

DIP 1 in the "ON" position (up).

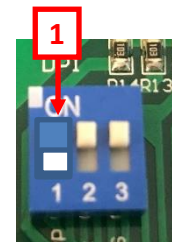

Deactivate the Energy Saving Sleep Mode by moving DIP 1 in the "OFF" position (down).



RESETTING THE HOT TANK OVERLOAD OR HIGH LIMIT SAFETY

1.	Red Compressor/Heater Switch must be in the <i>O=OFF</i> position	
2.	Unplug the Power Cord from rear of <i>WL2FL Water Treatment System</i> .	
3.	Remove the Side Panel by removing the Front Hatch and Side Panels.	
4.	Locate the Hot Tank	
5.	Press the Reset Button	
6.	Replace the Lower Front Panel.	
7.	Plug in the Power Cord.	
8.	Turn on the Red Compressor / Heater Switch <i>I=ON</i> position The Hot and Cold Tanks must be filled with water BEFORE turning on the Red Heater and Compressor Switch.	
9.	Verify the cooler is fully operational before installing it at the customers' site.	