

WL800 EXPLODED VIEW AND PARTS LIST

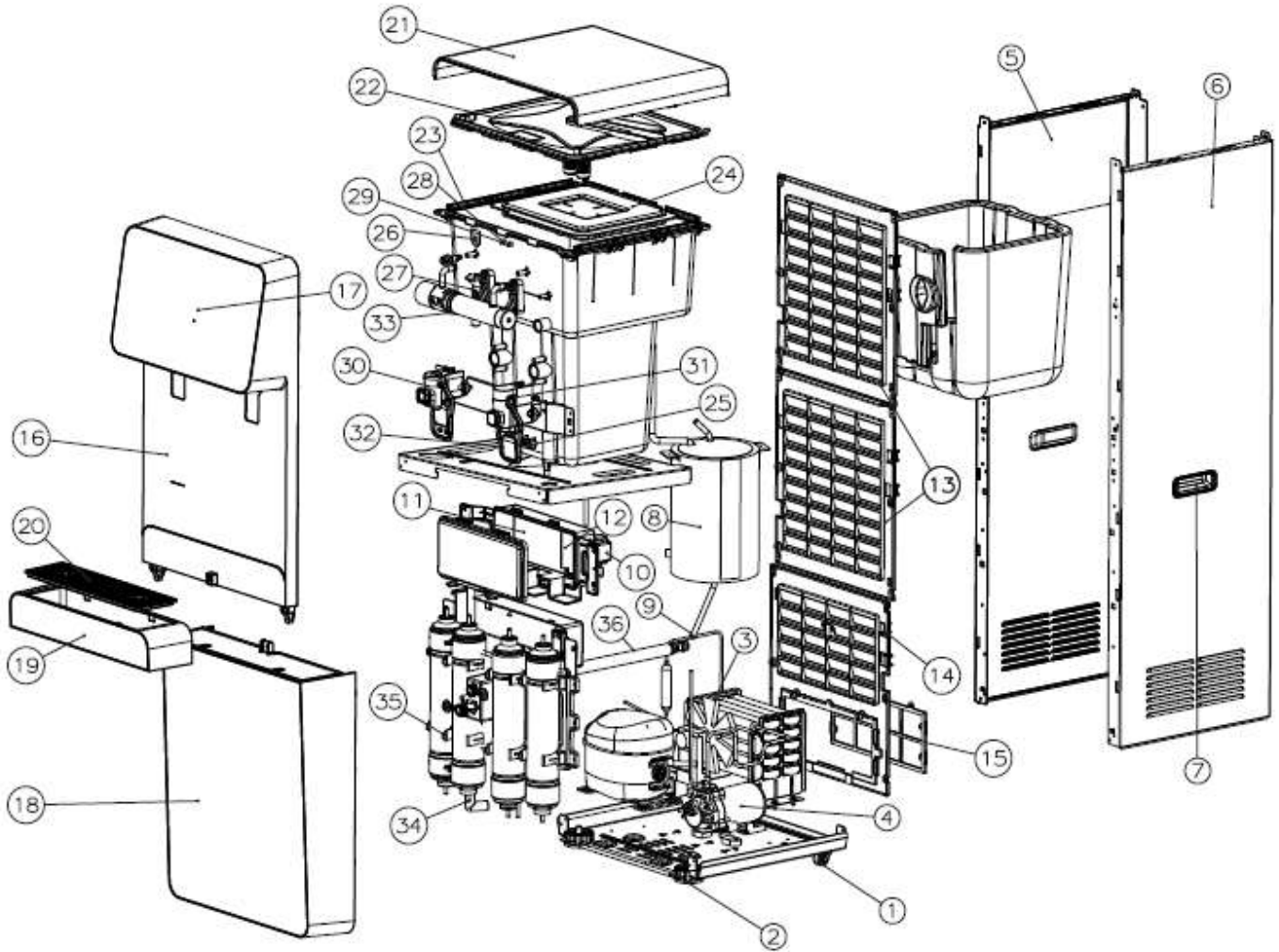

WL800 PARTS LIST



No.	P/N	Description	WLCP P/N	Stocked?	Image
1	3103311	Caster-B	16-5000 Same as 16-1202	Yes	
2	3306158	Black Caster - E	16-5005	Yes	
3	3123934	Fan – Unit Assembly	Fan Assembly N/A	16-1208 Yes	
4	3122366	Booster Pump	16-5200	Yes	
5	3123936	Left Side Cover Assembly – with Handle	16-5010	Yes	
6	3123937	Right Side Cover Assembly – with Handle	16-5015	Yes	
7	3101463	Handle	16-1096	Yes	
8	3123938	Heating Tank Assembly	16-5020	Yes	
9	3306113	Hot Water Drain Assembly Connector	16-5025	Yes	
10	3306116	Ballast	16-5030	Yes	
11	3123939	PBA-Main Assembly	16-5035	Yes	

12	3123940	PBA-SMPS	16-5040	Yes	
13	3110507	Rear Cover – A	16-5045	Yes	
14	3110508	Rear Cover Assembly – B	16-5050	Yes	
15	3210636	Air Filter	16-5055	Yes	
16	3123945	Upper Front Cover – Needs Silver Insert	16-5060	Yes	
17	3123947	PBA-Front Cover Assembly	16-5065	Yes	
18	3123948	Front Bottom Cover – Needs Silver Insert	16-5070	Yes	
19	3123949	Tray Assembly	16-5075	Yes	
20	3224223	Grill	16-5080	Yes	
21	3123950	Top Cover Assembly	16-5085	Yes	

22	3123944	CAP – Main Tank Assembly	16-5090	Yes	
23	3112502	Clip – Main Tank Sealing	16-5095	Yes	
24	3306123	Separator Board	16-5100	Yes	
25	3110565	Cold Sensor - Temperature Assembly	16-5105	Yes	
26	3306120	Sensor – CTS Water Level N – Upper - White	16-5110	Yes	
27	3306121	Sensor – CTS Water Level P – Lower – Blue	16-5115	Yes	
28	3306122	Overflow Sensor	N/A	No	
29	3110569	Overflow Sensor Assembly Harness	16-5120	Yes	
30	3306114	Hot Water Faucet Safety Assembly	16-5125	Yes	
31	3123952	Cold Water Faucet Assembly	16-5130	Yes	

32	3306115	Faucet Lever – Rubber	16-5135	Yes	
33	3123954	Ultra Violet Sterilizer Module Assembly	16-5140	Yes	
34	3306125	Automation Drain Control Valve	16-1100	Yes	
35	3306127	Filter C2 Clip	16-5145	Yes	
36	3103373	Cold Water Drain Assembly Connector	16-5150	Yes	
Not shown	3105086	Valve –Feed NOS	16-5155	Yes	
Not shown	3302612	LPS Sensor –E Assembly	16-1112	Yes	
Not shown	3123935	Leakage Sensor	16-5160	Yes	
Not shown	3306111	Hot Tank Overload / High Limit – Bimetal	16-5165		

Not shown	3306112	Hot Water Temperature Sensor	16-5170	Yes	
Not shown	3224211	Power Cord Assembly	16-5175	Yes	
Not shown	3306117	Snap Ring – E Ring	N/A	No	
Not shown	3100029	Spring	N/A	No	
Not shown	3306118	Support	N/A	No	
Not shown	3103235	Ultra-Violet Sterilizer SUS - Clip	N/A	No	
Not shown	3123955	UV Filter Hose	N/A	No	
Not shown	3306124	Tap Hose	N/A	No	
Not shown	3300750	Elbow Fitting - White	16-5180	Yes	

Not shown	3114063	Elbow Check Valve	16-5185	Yes	
Not shown	3105091	Elbow Fitting – Gray	16-5190	Yes	
Not shown	3302908	Straight Fitting – Gray	N/A	No	
Not shown	3306126 or 3303341 Interchangeable	Faucet Cap	16-5195 or 16-1160 interchangeable	Yes	